

Supplement



Digital Standard DVB-H

R&S[®] AMU-K52
1402.9557.02

R&S[®] SMATE-K52
1404.7800.02

R&S[®] SMJ-K52
1404.2106.02

R&S[®] SMU-K52
1408.7010.02

R&S[®] AFQ-K252
1401.5858.02

R&S[®] AMU-K252
1402.9505.02

R&S[®] SMJ-K252
1409.2406.02

R&S[®] SMU-K252
1408.7510.02



Dear Customer,

The Signal Generator includes software developed by the OpenSSL Project for use in the OpenSSL Toolkit (<http://www.openssl.org/>).

R&S® is a registered trademark of Rohde & Schwarz GmbH & Co. KG.
Trade names are trademarks of the owners.

Grouped Safety Messages









Make sure to read through and observe the following safety instructions!







All plants and locations of the Rohde & Schwarz group of companies make every effort to keep the safety standard of our products up to date and to offer our customers the highest possible degree of safety. Our products and the auxiliary equipment required for them are designed and tested in accordance with the relevant safety standards. Compliance with these standards is continuously monitored by our quality assurance system. The product described here has been designed and tested in accordance with the EC Certificate of Conformity and has left the manufacturer's plant in a condition fully complying with safety standards. To maintain this condition and to ensure safe operation, observe all instructions and warnings provided in this manual. If you have any questions regarding these safety instructions, the Rohde & Schwarz group of companies will be happy to answer them.

Furthermore, it is your responsibility to use the product in an appropriate manner. This product is designed for use solely in industrial and laboratory environments or, if expressly permitted, also in the field and must not be used in any way that may cause personal injury or property damage. You are responsible if the product is used for an intention other than its designated purpose or in disregard of the manufacturer's instructions. The manufacturer shall assume no responsibility for such use of the product.

The product is used for its designated purpose if it is used in accordance with its product documentation and within its performance limits (see data sheet, documentation, the following safety instructions). Using the product requires technical skills and a basic knowledge of English. It is therefore essential that only skilled and specialized staff or thoroughly trained personnel with the required skills be allowed to use the product. If personal safety gear is required for using Rohde & Schwarz products, this will be indicated at the appropriate place in the product documentation. Keep the basic safety instructions and the product documentation in a safe place and pass them on to the subsequent users.

Symbols and safety labels

							
Observe product documentation	Weight indication for units >18 kg	Danger of electric shock	Warning! Hot surface	PE terminal	Ground	Ground terminal	Attention! Electrostatic sensitive devices

					
Supply voltage ON/OFF	Standby indication	Direct current (DC)	Alternating current (AC)	Direct/alternating current (DC/AC)	Device fully protected by double/reinforced insulation

Observing the safety instructions will help prevent personal injury or damage of any kind caused by dangerous situations. Therefore, carefully read through and adhere to the following safety instructions before putting the product into operation. It is also absolutely essential to observe the additional safety instructions on personal safety that appear in relevant parts of the product documentation. In these safety instructions, the word "product" refers to all merchandise sold and distributed by the Rohde & Schwarz group of companies, including instruments, systems and all accessories.

Tags and their meaning

DANGER	DANGER indicates a hazardous situation which, if not avoided, will result in death or serious injury.
WARNING	WARNING indicates a hazardous situation which, if not avoided, could result in death or serious injury.
CAUTION	CAUTION indicates a hazardous situation which, if not avoided, may result in minor or moderate injury.
NOTICE	NOTICE indicates a property damage message. In the product documentation, the word ATTENTION is used synonymously.

These tags are in accordance with the standard definition for civil applications in the European Economic Area. Definitions that deviate from the standard definition may also exist in other economic areas or military applications. It is therefore essential to make sure that the tags described here are always used only in connection with the related product documentation and the related product. The use of tags in connection with unrelated products or documentation can result in misinterpretation and thus contribute to personal injury or material damage.

Basic safety instructions

1. The product may be operated only under the operating conditions and in the positions specified by the manufacturer. Its ventilation must not be obstructed during operation. Unless otherwise specified, the following requirements apply to Rohde & Schwarz products:
prescribed operating position is always with the housing floor facing down, IP protection 2X, pollution severity 2, overvoltage category 2, use only in enclosed spaces, max. operation altitude 2000 m above sea level, max. transport altitude 4500 m above sea level.
A tolerance of $\pm 10\%$ shall apply to the nominal voltage and of $\pm 5\%$ to the nominal frequency.
2. Applicable local or national safety regulations and rules for the prevention of accidents must be observed in all work performed. The product may be opened only by authorized, specially trained personnel. Prior to performing any work on the product or opening the product, the product must be disconnected from the supply network. Any adjustments, replacements of parts, maintenance or repair must be carried out only by technical personnel authorized by Rohde & Schwarz. Only original parts may be used for replacing parts relevant to safety (e.g. power switches, power transformers, fuses). A safety test must always be performed after parts relevant to safety have been replaced (visual inspection, PE conductor test, insulation resistance measurement, leakage current measurement, functional test).
3. As with all industrially manufactured goods, the use of substances that induce an allergic reaction (allergens, e.g. nickel) such as aluminum cannot be generally excluded. If you develop an allergic reaction (such as a skin rash, frequent sneezing, red eyes or respiratory difficulties), consult a physician immediately to determine the cause.
4. If products/components are mechanically and/or thermally processed in a manner that goes beyond their intended use, hazardous substances (heavy-metal dust such as lead, beryllium, nickel) may be released. For this reason, the product may only be disassembled, e.g. for disposal purposes, by specially trained personnel. Improper disassembly may be hazardous to your health. National waste disposal regulations must be observed.

5. If handling the product yields hazardous substances or fuels that must be disposed of in a special way, e.g. coolants or engine oils that must be replenished regularly, the safety instructions of the manufacturer of the hazardous substances or fuels and the applicable regional waste disposal regulations must be observed. Also observe the relevant safety instructions in the product documentation.
6. Depending on the function, certain products such as RF radio equipment can produce an elevated level of electromagnetic radiation. Considering that unborn life requires increased protection, pregnant women should be protected by appropriate measures. Persons with pacemakers may also be endangered by electromagnetic radiation. The employer/operator is required to assess workplaces where there is a special risk of exposure to radiation and, if necessary, take measures to avert the danger.
7. Operating the products requires special training and intense concentration. Make certain that persons who use the products are physically, mentally and emotionally fit enough to handle operating the products; otherwise injuries or material damage may occur. It is the responsibility of the employer to select suitable personnel for operating the products.
8. Prior to switching on the product, it must be ensured that the nominal voltage setting on the product matches the nominal voltage of the AC supply network. If a different voltage is to be set, the power fuse of the product may have to be changed accordingly.
9. In the case of products of safety class I with movable power cord and connector, operation is permitted only on sockets with earthing contact and protective earth connection.
10. Intentionally breaking the protective earth connection either in the feed line or in the product itself is not permitted. Doing so can result in the danger of an electric shock from the product. If extension cords or connector strips are implemented, they must be checked on a regular basis to ensure that they are safe to use.
11. If the product has no power switch for disconnection from the AC supply, the plug of the connecting cable is regarded as the disconnecting device. In such cases, it must be ensured that the power plug is easily reachable and accessible at all times (corresponding to the length of connecting cable, approx. 2 m). Functional or electronic switches are not suitable for providing disconnection from the AC supply. If products without power switches are integrated in racks or systems, a disconnecting device must be provided at the system level.
12. Never use the product if the power cable is damaged. Check the power cable on a regular basis to ensure that it is in proper operating condition. By taking appropriate safety measures and carefully laying the power cable, ensure that the cable cannot be damaged and that no one can be hurt by e.g. tripping over the cable or suffering an electric shock.
13. The product may be operated only from TN/TT supply networks fused with max. 16 A (higher fuse only after consulting with the Rohde & Schwarz group of companies).
14. Do not insert the plug into sockets that are dusty or dirty. Insert the plug firmly and all the way into the socket. Otherwise, this can result in sparks, fire and/or injuries.
15. Do not overload any sockets, extension cords or connector strips; doing so can cause fire or electric shocks.
16. For measurements in circuits with voltages $V_{\text{rms}} > 30 \text{ V}$, suitable measures (e.g. appropriate measuring equipment, fusing, current limiting, electrical separation, insulation) should be taken to avoid any hazards.
17. Ensure that the connections with information technology equipment comply with IEC 950/EN 60950.
18. Unless expressly permitted, never remove the cover or any part of the housing while the product is in operation. Doing so will expose circuits and components and can lead to injuries, fire or damage to the product.
19. If a product is to be permanently installed, the connection between the PE terminal on site and the product's PE conductor must be made first before any other connection is made. The product may be installed and connected only by a license electrician.

Grouped Safety Messages

20. For permanently installed equipment without built-in fuses, circuit breakers or similar protective devices, the supply circuit must be fused in such a way that suitable protection is provided for users and products.
21. Do not insert any objects into the openings in the housing that are not designed for this purpose. Never pour any liquids onto or into the housing. This can cause short circuits inside the product and/or electric shocks, fire or injuries.
22. Use suitable overvoltage protection to ensure that no overvoltage (such as that caused by a thunderstorm) can reach the product. Otherwise the operating personnel will be endangered by electric shocks.
23. Rohde & Schwarz products are not protected against penetration of liquids, unless otherwise specified (see also safety instruction 1.). If this is not taken into account, there exists the danger of electric shock for the user or damage to the product, which can also lead to personal injury.
24. Never use the product under conditions in which condensation has formed or can form in or on the product, e.g. if the product was moved from a cold to a warm environment.
25. Do not close any slots or openings on the product, since they are necessary for ventilation and prevent the product from overheating. Do not place the product on soft surfaces such as sofas or rugs or inside a closed housing, unless this is well ventilated.
26. Do not place the product on heat-generating devices such as radiators or fan heaters. The temperature of the environment must not exceed the maximum temperature specified in the data sheet.
27. Batteries and storage batteries must not be exposed to high temperatures or fire. Keep batteries and storage batteries away from children. Do not short-circuit batteries and storage batteries.
If batteries or storage batteries are improperly replaced, this can cause an explosion (warning: lithium cells). Replace the battery or storage battery only with the matching Rohde & Schwarz type (see spare parts list). Batteries and storage batteries must be recycled and kept separate from residual waste. Batteries and storage batteries that contain lead, mercury or cadmium are hazardous waste. Observe the national regulations regarding waste disposal and recycling.
28. Please be aware that in the event of a fire, toxic substances (gases, liquids etc.) that may be hazardous to your health may escape from the product.
29. The product can be very heavy. Be careful when moving it to avoid back or other physical injuries.
30. Do not place the product on surfaces, vehicles, cabinets or tables that for reasons of weight or stability are unsuitable for this purpose. Always follow the manufacturer's installation instructions when installing the product and fastening it to objects or structures (e.g. walls and shelves).
31. Handles on the products are designed exclusively for personnel to hold or carry the product. It is therefore not permissible to use handles for fastening the product to or on means of transport such as cranes, fork lifts, wagons, etc. The user is responsible for securely fastening the products to or on the means of transport and for observing the safety regulations of the manufacturer of the means of transport. Noncompliance can result in personal injury or material damage.
32. If you use the product in a vehicle, it is the sole responsibility of the driver to drive the vehicle safely. Adequately secure the product in the vehicle to prevent injuries or other damage in the event of an accident. Never use the product in a moving vehicle if doing so could distract the driver of the vehicle. The driver is always responsible for the safety of the vehicle. The manufacturer assumes no responsibility for accidents or collisions.
33. If a laser product (e.g. a CD/DVD drive) is integrated in a Rohde & Schwarz product, do not use any other settings or functions than those described in the product documentation. Otherwise this may be hazardous to your health, since the laser beam can cause irreversible damage to your eyes. Never try to take such products apart, and never look into the laser beam.
34. Prior to cleaning, disconnect the product from the AC supply. Use a soft, non-linting cloth to clean the product. Never use chemical cleaning agents such as alcohol, acetone or diluent for cellulose lacquers.

Informaciones elementales de seguridad

¡Es imprescindible leer y observar las siguientes instrucciones e informaciones de seguridad!







El principio del grupo de empresas Rohde & Schwarz consiste en tener nuestros productos siempre al día con los estándares de seguridad y de ofrecer a nuestros clientes el máximo grado de seguridad. Nuestros productos y todos los equipos adicionales son siempre fabricados y examinados según las normas de seguridad vigentes. Nuestra sección de gestión de la seguridad de calidad controla constantemente que sean cumplidas estas normas. El presente producto ha sido fabricado y examinado según el comprobante de conformidad adjunto según las normas de la CE y ha salido de nuestra planta en estado impecable según los estándares técnicos de seguridad. Para poder preservar este estado y garantizar un funcionamiento libre de peligros, el usuario deberá atenerse a todas las indicaciones, informaciones de seguridad y notas de alerta. El grupo de empresas Rohde & Schwarz está siempre a su disposición en caso de que tengan preguntas referentes a estas informaciones de seguridad.

Además queda en la responsabilidad del usuario utilizar el producto en la forma debida. Este producto está destinado exclusivamente al uso en la industria y el laboratorio o, si ha sido expresamente autorizado, para aplicaciones de campo y de ninguna manera deberá ser utilizado de modo que alguna persona/cosa pueda sufrir daño. El uso del producto fuera de sus fines definidos o despreciando las informaciones de seguridad del fabricante queda en la responsabilidad del usuario. El fabricante no se hace en ninguna forma responsable de consecuencias a causa del mal uso del producto.

Se parte del uso correcto del producto para los fines definidos si el producto es utilizado dentro de las instrucciones de la correspondiente documentación de producto y dentro del margen de rendimiento definido (ver hoja de datos, documentación, informaciones de seguridad que siguen). El uso del producto hace necesarios conocimientos profundos y conocimientos básicas del idioma inglés. Por eso se debe tener en cuenta que el producto sólo pueda ser operado por personal especializado o personas minuciosamente instruidas con las capacidades correspondientes. Si fuera necesaria indumentaria de seguridad para el uso de productos de R&S, encontrará la información debida en la documentación del producto en el capítulo correspondiente. Guarde bien las informaciones de seguridad elementales, así como la documentación del producto y entréguela a usuarios posteriores.

Símbolos y definiciones de seguridad

							
Ver documentación de producto	Informaciones para maquinaria con un peso de > 18kg	Peligro de golpe de corriente	¡Advertencia! Superficie caliente	Conexión a conductor protector	Conexión a tierra	Conexión a masa conductora	¡Cuidado! Elementos de construcción con peligro de carga electrostática

					
Potencia EN MARCHA/PARADA	Indicación Stand-by	Corriente continua DC	Corriente alterna AC	Corriente continua/- alterna DC/AC	El aparato está protegido en su totalidad por un aislamiento de doble refuerzo

Tener en cuenta las informaciones de seguridad sirve para tratar de evitar daños y peligros de toda clase. Es necesario de que se lean las siguientes informaciones de seguridad concienzudamente y se tengan en cuenta debidamente antes de la puesta en funcionamiento del producto. También deberán ser tenidas en cuenta las informaciones para la protección de personas que encontrarán en el capítulo correspondiente de la documentación de producto y que también son obligatorias de seguir. En las informaciones de seguridad actuales hemos juntado todos los objetos vendidos por el grupo de empresas Rohde & Schwarz bajo la denominación de „producto“, entre ellos también aparatos, instalaciones así como toda clase de accesorios.

Palabras de señal y su significado

PELIGRO	Identifica un peligro directo con riesgo elevado de provocar muerte o lesiones de gravedad si no se toman las medidas oportunas.
ADVERTENCIA	Identifica un posible peligro con riesgo medio de provocar muerte o lesiones (de gravedad) si no se toman las medidas oportunas.
ATENCIÓN	Identifica un peligro con riesgo reducido de provocar lesiones de gravedad media o leve si no se toman las medidas oportunas.
AVISO	Indica la posibilidad de utilizar mal el producto y a consecuencia dañarlo.

En la documentación del producto se emplea de forma sinónima el término CUIDADO.

Las palabras de señal corresponden a la definición habitual para aplicaciones civiles en el área económica europea. Pueden existir definiciones diferentes a esta definición en otras áreas económicas o en aplicaciones militares. Por eso se deberá tener en cuenta que las palabras de señal aquí descritas sean utilizadas siempre solamente en combinación con la correspondiente documentación de producto y solamente en combinación con el producto correspondiente. La utilización de las palabras de señal en combinación con productos o documentaciones que no les correspondan puede llevar a malinterpretaciones y tener por consecuencia daños en personas u objetos.

Informaciones de seguridad elementales

1. El producto solamente debe ser utilizado según lo indicado por el fabricante referente a la situación y posición de funcionamiento sin que se obstruya la ventilación. Si no se convino de otra manera, es para los productos R&S válido lo que sigue:
como posición de funcionamiento se define por principio la posición con el suelo de la caja para abajo, modo de protección IP 2X, grado de suciedad 2, categoría de sobrecarga eléctrica 2, utilizar solamente en estancias interiores, utilización hasta 2000 m sobre el nivel del mar, transporte hasta 4.500 m sobre el nivel del mar.
Se aplicará una tolerancia de $\pm 10\%$ sobre el voltaje nominal y de $\pm 5\%$ sobre la frecuencia nominal.
2. En todos los trabajos deberán ser tenidas en cuenta las normas locales de seguridad de trabajo y de prevención de accidentes. El producto solamente debe de ser abierto por personal especializado autorizado. Antes de efectuar trabajos en el producto o abrirlo deberá este ser desconectado de la corriente. El ajuste, el cambio de partes, la manutención y la reparación deberán ser solamente efectuadas por electricistas autorizados por R&S. Si se reponen partes con importancia para los aspectos de seguridad (por ejemplo el enchufe, los transformadores o los fusibles), solamente podrán ser sustituidos por partes originales. Después de cada recambio de partes elementales para la seguridad deberá ser efectuado un control de seguridad (control a primera vista, control de conductor protector, medición de resistencia de aislamiento, medición de la corriente conductora, control de funcionamiento).

3. Como en todo producto de fabricación industrial no puede ser excluido en general de que se produzcan al usarlo elementos que puedan generar alergias, los llamados elementos alergénicos (por ejemplo el níquel). Si se produjeran en el trato con productos R&S reacciones alérgicas, como por ejemplo urticaria, estornudos frecuentes, irritación de la conjuntiva o dificultades al respirar, se deberá consultar inmediatamente a un médico para averiguar los motivos de estas reacciones.
 4. Si productos / elementos de construcción son tratados fuera del funcionamiento definido de forma mecánica o térmica, pueden generarse elementos peligrosos (polvos de sustancia de metales pesados como por ejemplo plomo, berilio, níquel). La partición elemental del producto, como por ejemplo sucede en el tratamiento de materias residuales, debe de ser efectuada solamente por personal especializado para estos tratamientos. La partición elemental efectuada inadecuadamente puede generar daños para la salud. Se deben tener en cuenta las directivas nacionales referentes al tratamiento de materias residuales.
 5. En el caso de que se produjeran agentes de peligro o combustibles en la aplicación del producto que debieran de ser transferidos a un tratamiento de materias residuales, como por ejemplo agentes refrigerantes que deben ser repuestos en periodos definidos, o aceites para motores, deberán ser tenidas en cuenta las prescripciones de seguridad del fabricante de estos agentes de peligro o combustibles y las regulaciones regionales para el tratamiento de materias residuales. Cuiden también de tener en cuenta en caso dado las prescripciones de seguridad especiales en la descripción del producto.
 6. Ciertos productos, como por ejemplo las instalaciones de radiocomunicación RF, pueden a causa de su función natural, emitir una radiación electromagnética aumentada. En vista a la protección de la vida en desarrollo deberían ser protegidas personas embarazadas debidamente. También las personas con un bypass pueden correr peligro a causa de la radiación electromagnética.
- El empresario/usuario está comprometido a valorar y señalar áreas de trabajo en las que se corra un riesgo aumentado de exposición a radiaciones para evitar riesgos.
7. La utilización de los productos requiere instrucciones especiales y una alta concentración en el manejo. Debe de ponerse por seguro de que las personas que manejen los productos estén a la altura de los requerimientos necesarios referente a sus aptitudes físicas, psíquicas y emocionales, ya que de otra manera no se pueden excluir lesiones o daños de objetos. El empresario lleva la responsabilidad de seleccionar el personal usuario apto para el manejo de los productos.
 8. Antes de la puesta en marcha del producto se deberá tener por seguro de que la tensión preseleccionada en el producto equivalga a la del la red de distribución. Si es necesario cambiar la preselección de la tensión también se deberán en caso dabo cambiar los fusibles correspondientes del producto.
 9. Productos de la clase de seguridad I con alimentación móvil y enchufe individual de producto solamente deberán ser conectados para el funcionamiento a tomas de corriente de contacto de seguridad y con conductor protector conectado.
 10. Queda prohibida toda clase de interrupción intencionada del conductor protector, tanto en la toma de corriente como en el mismo producto. Puede tener como consecuencia el peligro de golpe de corriente por el producto. Si se utilizaran cables o enchufes de extensión se deberá poner al seguro que es controlado su estado técnico de seguridad.
 11. Si el producto no está equipado con un interruptor para desconectarlo de la red, se deberá considerar el enchufe del cable de distribución como interruptor. En estos casos deberá asegurar de que el enchufe sea de fácil acceso y nabejo (según la medida del cable de distribución, aproximadamente 2 m). Los interruptores de función o electrónicos no son aptos para el corte de la red eléctrica. Si los productos sin interruptor están integrados en bastidores o instalaciones, se deberá instalar el interruptor al nivel de la instalación.

12. No utilice nunca el producto si está dañado el cable eléctrico. Compruebe regularmente el correcto estado de los cables de conexión a red. Asegure a través de las medidas de protección y de instalación adecuadas de que el cable de eléctrico no pueda ser dañado o de que nadie pueda ser dañado por él, por ejemplo al tropezar o por un golpe de corriente.
13. Solamente está permitido el funcionamiento en redes de distribución TN/TT aseguradas con fusibles de como máximo 16 A (utilización de fusibles de mayor amperaje sólo previa consulta con el grupo de empresas Rohde & Schwarz).
14. Nunca conecte el enchufe en tomas de corriente sucias o llenas de polvo. Introduzca el enchufe por completo y fuertemente en la toma de corriente. Si no tiene en consideración estas indicaciones se arriesga a que se originen chispas, fuego y/o heridas.
15. No sobrecargue las tomas de corriente, los cables de extensión o los enchufes de extensión ya que esto pudiera causar fuego o golpes de corriente.
16. En las mediciones en circuitos de corriente con una tensión de entrada de $U_{eff} > 30$ V se deberá tomar las precauciones debidas para impedir cualquier peligro (por ejemplo medios de medición adecuados, seguros, limitación de tensión, corte protector, aislamiento etc.).
17. En caso de conexión con aparatos de la técnica informática se deberá tener en cuenta que estos cumplan los requisitos del estándar IEC950/EN60950.
18. A menos que esté permitido expresamente, no retire nunca la tapa ni componentes de la carcasa mientras el producto esté en servicio. Esto pone a descubierto los cables y componentes eléctricos y puede causar heridas, fuego o daños en el producto.
19. Si un producto es instalado fijamente en un lugar, se deberá primero conectar el conductor protector fijo con el conductor protector del aparato antes de hacer cualquier otra conexión. La instalación y la conexión deberán ser efectuadas por un electricista especializado.
20. En caso de que los productos que son instalados fijamente en un lugar sean sin protector implementado, autointerruptor o similares objetos de protección, el circuito de suministro de corriente deberá estar protegido de manera que usuarios y productos estén suficientemente protegidos.
21. Por favor, no introduzca ningún objeto que no esté destinado a ello en los orificios de la caja del aparato. No vierta nunca ninguna clase de líquidos sobre o en la caja. Esto puede producir cortocircuitos en el producto y/o puede causar golpes de corriente, fuego o heridas.
22. Asegúrese con la protección adecuada de que no pueda originarse en el producto una sobrecarga por ejemplo a causa de una tormenta. Si no se verá el personal que lo utilice expuesto al peligro de un golpe de corriente.
23. Los productos R&S no están protegidos contra líquidos si no es que exista otra indicación, ver también punto 1. Si no se tiene en cuenta esto se arriesga el peligro de golpe de corriente para el usuario o de daños en el producto lo cual también puede llevar al peligro de personas.
24. No utilice el producto bajo condiciones en las que pueda producirse y se hayan producido líquidos de condensación en o dentro del producto como por ejemplo cuando se desplaza el producto de un lugar frío a un lugar caliente.
25. Por favor no cierre ninguna ranura u orificio del producto, ya que estas son necesarias para la ventilación e impiden que el producto se caliente demasiado. No pongan el producto encima de materiales blandos como por ejemplo sofás o alfombras o dentro de una caja cerrada, si esta no está suficientemente ventilada.
26. No ponga el producto sobre aparatos que produzcan calor, como por ejemplo radiadores o calentadores. La temperatura ambiental no debe superar la temperatura máxima especificada en la hoja de datos.

27. Baterías y acumuladores no deben de ser expuestos a temperaturas altas o al fuego. Guardar baterías y acumuladores fuera del alcance de los niños. No cortocircuitar baterías ni acumuladores. Si las baterías o los acumuladores no son cambiados con la debida atención existirá peligro de explosión (atención células de litio). Cambiar las baterías o los acumuladores solamente por los del tipo R&S correspondiente (ver lista de piezas de recambio). Las baterías y acumuladores deben reutilizarse y no deben acceder a los vertederos. Las baterías y acumuladores que contienen plomo, mercurio o cadmio deben tratarse como residuos especiales. Respete en esta relación las normas nacionales de evacuación y reciclaje.
28. Por favor tengan en cuenta que en caso de un incendio pueden desprenderse del producto agentes venenosos (gases, líquidos etc.) que pueden generar daños a la salud.
29. El producto puede poseer un peso elevado. Muévelo con cuidado para evitar lesiones en la espalda u otras partes corporales.
30. No sitúe el producto encima de superficies, vehículos, estantes o mesas, que por sus características de peso o de estabilidad no sean aptas para él. Siga siempre las instrucciones de instalación del fabricante cuando instale y asegure el producto en objetos o estructuras (por ejemplo paredes y estantes).
31. Las asas instaladas en los productos sirven solamente de ayuda para el manejo que solamente está previsto para personas. Por eso no está permitido utilizar las asas para la sujeción en o sobre medios de transporte como por ejemplo grúas, carretillas elevadoras de horquilla, carros etc. El usuario es responsable de que los productos sean sujetados de forma segura a los medios de transporte y de que las prescripciones de seguridad del fabricante de los medios de transporte sean observadas. En caso de que no se tengan en cuenta pueden causarse daños en personas y objetos.
32. Si llega a utilizar el producto dentro de un vehículo, queda en la responsabilidad absoluta del conductor que conducir el vehículo de manera segura. Asegure el producto dentro del vehículo debidamente para evitar en caso de un accidente las lesiones u otra clase de daños. No utilice nunca el producto dentro de un vehículo en movimiento si esto pudiera distraer al conductor. Siempre queda en la responsabilidad absoluta del conductor la seguridad del vehículo. El fabricante no asumirá ninguna clase de responsabilidad por accidentes o colisiones.
33. Dado el caso de que esté integrado un producto de láser en un producto R&S (por ejemplo CD/DVD-ROM) no utilice otras instalaciones o funciones que las descritas en la documentación de producto. De otra manera pondrá en peligro su salud, ya que el rayo láser puede dañar irreversiblemente sus ojos. Nunca trate de descomponer estos productos. Nunca mire dentro del rayo láser.
34. Antes de proceder a la limpieza, desconecte el producto de la red. Realice la limpieza con un paño suave, que no se deshilache. No utilice de ninguna manera agentes limpiadores químicos como, por ejemplo, alcohol, acetona o nitrodiluyente.

Contents

Digital Standard DVB-H	1
Introduction-DVB-H	1
Modulation System.....	1
Extensions to DVB-T	6
DVB-H Menu	9
General Settings for DVB-H Signals	9
System Configuration - DVB-H.....	14
TPS Settings.....	17
Filtering/Clipping Settings- DVB-H	21
Trigger-Marker-Clock - DVB-H	25
SOURce:BB:DVB-H-Subsystem- Remote-Control Commands	34
General Commands	34
System Configuration	54
TPS Settings.....	58
Alphabetical List of Commands	60
Index.....	62

Digital Standard DVB-H

Introduction-DVB-H

The R&S Signal Generator enables you to generate signals in accordance with the DVB-H (Digital Video Broadcasting - Transmission System for Handheld Terminals) standard.

Modulation System

The following block diagram shows the components of the DVB-H transmission system.

Note:

In this release, only the high-priority input is available.

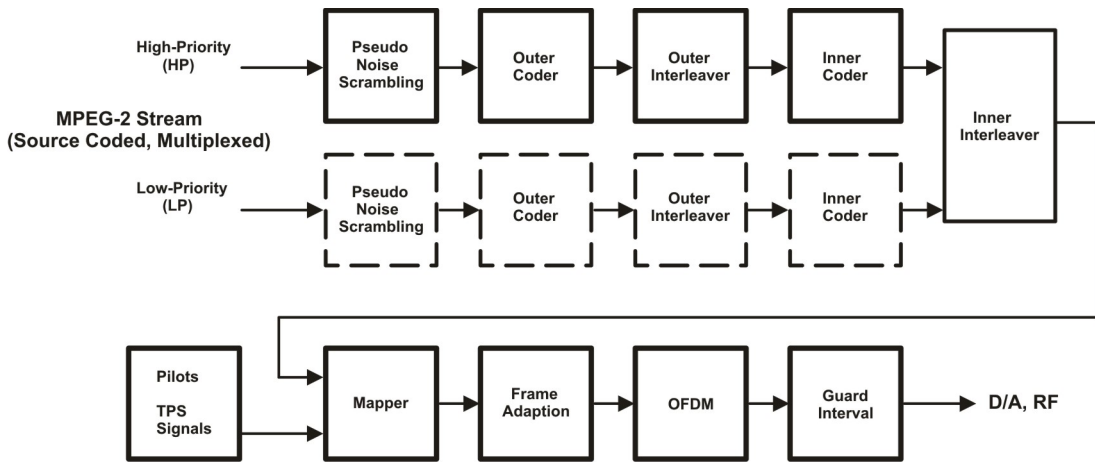
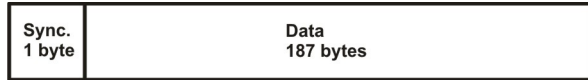

Fig. 1 Components of the Transmission System DVB-H

Pseudo Noise Scrambler

The MPEG-2 transport packet stream is organized in fixed packet length of 188 bytes. This includes 187 data bytes and one sync byte.



The data packets of the input stream are transformed to a Pseudo Random Binary Sequence (PRBS) in order to obtain a bit sequence that has a positive effect on the transmitted RF spectrum.

The PRBS polynomial is specified as: $1 + x^{14} + x^{15}$

The PRBS generator is loaded with the sequence "100101010000000" at the start of every eight transport packet. To provide an initialization signal for the descrambler, the sync byte of the first transport packet in a group of eight packets is bit-wise inverted from 0x47 to 0xb8, whereas the sync bytes of the next seven packets remain 0x47. After that, the PRBS generator runs continuously through the eight packets with a PRBS period of 1503 bytes (8 packets * 188 bytes - 1sync byte).

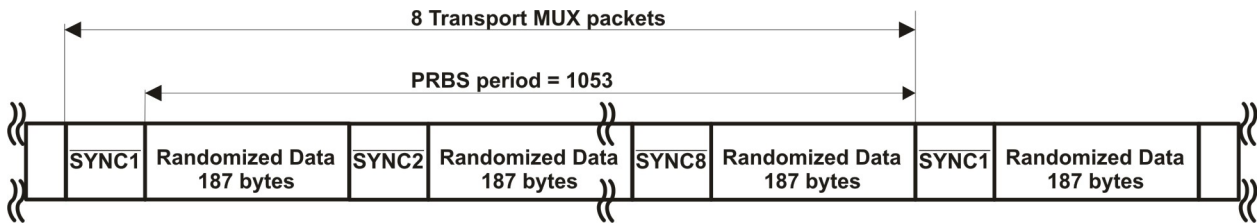

Outer Coder

The outer coder is a Reed-Solomon encoder RS (204, 188, t = 8). The RS coding is applied to each randomized transport packet (188 byte) to generate an error protected packet with a length of 204 bytes (188 randomized transport packets + 16 parity bytes). With this RS code up to eight erroneous bytes can be detected in the transport stream packet and corrected.

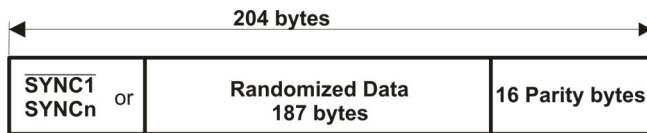

Outer Interleaver

The outer interleaver is a convolutional interleaver with I = 12 branches. Each branch "j" is a FIFO shift register with depth $j \times 17$ cells = 204 bytes.



Inner Coder

The inner coder is a punctured convolution code, based on a mother convolutional code of rate 1/2 with 64 states. The inner coder encodes the input data, punctures certain bits to obtain higher code rates, and serializes the I/Q symbols to be transmitted. The integrated puncturer removes bits from the redundant data stream. Puncturing slightly impairs the characteristics of the code. The code rates that can be set are 1/2, 2/3, 3/4, 5/6 and 7/8. The code rate can be selected according to the required transmission characteristics of the system.

Code Rates r	Puncturing Pattern	Transmitted Sequence (after parallel-to-serial conversions)
1/2	X:1 Y:1	X_1Y_1
2/3	X:10 Y:11	$X_1Y_1Y_2$
3/4	X:101 Y:110	$X_1Y_1Y_2X_3$
5/6	X:10101 Y:11010	$X_1Y_1Y_2X_3Y_4X_5$
7/8	X:1000101 Y:111010	$X_1Y_1Y_2Y_3Y_4X_5Y_6X_7$

Fig. 2 Puncturing pattern and transmitted sequence after conversion for the possible code rates

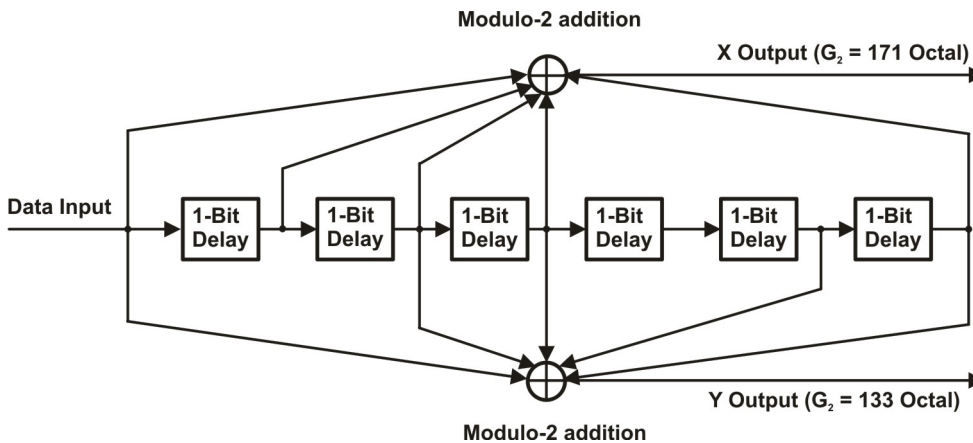

Fig. 3 Mother convolutional code rate of 1/2

Inner Interleaver

The inner interleaver consists of a bit-wise interleaving followed by symbol interleaving. Both interleaving processes are block based.

In non-hierarchical mode, the input bit stream for the bit-wise interleaving is multiplexed into v sub-streams depending on the modulation mode with v representing the number of bits/symbol:

Modulation Mode	Sub-Stream v
QPSK	2
16-QAM	4
64-QAM	6

In hierachical mode, the high priority stream is demultiplexed into two sub-streams and the low priority stream is demultiplexed into $v-2$ sub-streams.

The outputs of the v bit interleavers are grouped to form the digital data symbols, such that each symbol of v bits will consist of exactly one bit from each of the v interleavers.

The purpose of the symbol interleaver is to map v bit words onto 1512 (2K mode), 3024 (4K mode), or 6048 (8K mode) active carriers per OFDM symbol. The symbol interleaver acts on blocks of 1512 (2K mode), 3024 (4K mode), or 6048 (8K mode) data symbols. Furthermore, for the interleaver is an in-depth mode available for 2K and 4K in which the interleaver always maps the v bit words onto 6048. This is described in detail in section "[4K Mode and In-Depth Interleavers](#)", page 6.

Mapper

All data carriers in one OFDM symbol are modulated using either QPSK, 16-QAM, or 64-QAM.

Additionally, for the hierarchical mode, non-uniform 16-QAM and non-uniform 64 QAM constellations are available with different values for parameter α . α ist the minimum distance separating two constellation points carrying different HP-bit values divided by the minimum distance separating any two constellation points. For non-hierarchical transmission, the constellation is shaped as if α is 1.

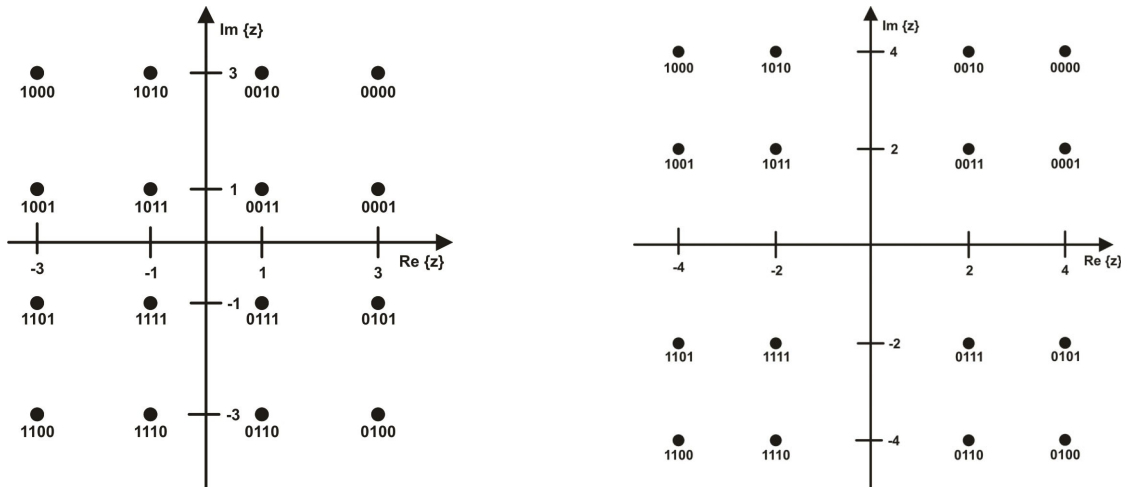

Fig. 4 16 QAM mapping with $\alpha = 1$

16 QAM mapping with $\alpha = 2$

Frame Adaption

The transmitted signal is organized in super-frames. Each super-frame consists of 4 frames.

Each frame contains scattered pilot cells, continual pilot carriers, and TPS carriers. The pilots can be used for frame synchronization, frequency synchronization, time synchronization, channel estimation, and transmission mode identification.

Each frame consists of 68 OFDM symbols. Each symbol consists of a guard interval and a useful part. The symbols in an OFDM frame are numbered from 0 to 67.

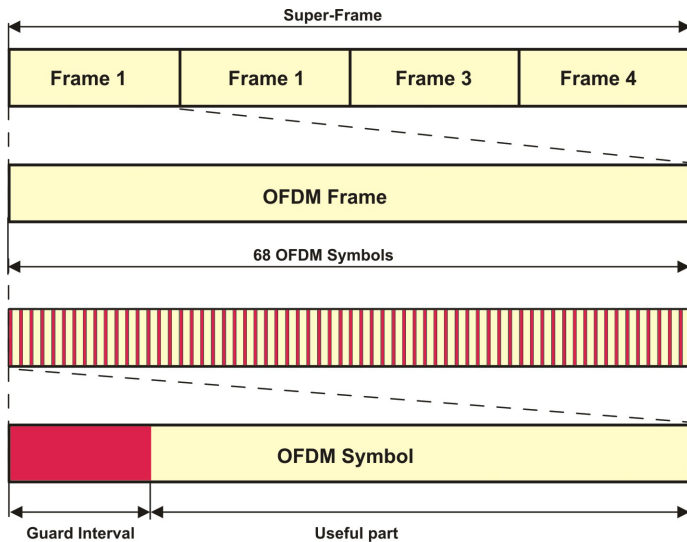

Fig. 5 OFDM frame structure

Each OFDM symbol is constituted by a set of carriers. The number of carriers depends on the OFDM mode:

OFDM Mode	No. of Carriers
2K	1705
4K	3409
8K	6817

Transport Parameter Signalling

The Transport Parameter Signalling (TPS) carriers are used to signalling parameters related to the transmission scheme. The TPS is transmitted parallel on 17 TPS carriers for the 2K mode, 34 carriers for the 4K mode, and 68 carriers for the 8K mode. Every TPS carrier in the same symbol conveys the same differentially encoded information bit.

The TPS parameter bits are described in section "[TPS Table - DVB-H](#)", page 18.

Extensions to DVB-T

The Digital Video Broadcasting - Handheld (DVB-H) standard is based on the earlier standard DVB-T, which is used for terrestrial digital broadcasting. DVB-H provides features to meet the specific requirements for handheld, mobile terminals such as

- power off some part of the reception chain to increase the battery duration
- ease access to the services when receivers switching to the next cell
- mitigate the effects of man-made noise and severe mobile multipath channels on the receiving capabilities
- offer sufficient flexibility and scalability to allow reception of services at various speeds
- offer the flexibility to be used in various transmission bands and channel bandwidths

The basic technical extensions that make it possible to receive digital video broadcasting services on handheld terminals are:

- 4K Mode and In-Depth Interleavers
- Time-Slicing
- Forward Error Correction for Multiprotocol Encapsulated Data (MPE-FEC)

4K Mode and In-Depth Interleavers

The additional 4K mode is an trade-off between transmission cell size and mobile reception capabilities to improve network planning flexibility. The 4K mode is suitable for single transmitter operation and for small and medium single frequency networks (SFN). It provides a Doppler tolerance allowing very high speed reception. The mobile reception is faster compared to the 8K mode and the cell size is bigger compared to the 2K mode.

The additional in-depth interleavers increase the flexibility of the interleaving for the 2K and 4K mode. The depth of the inner interleaver is enlarged to four consecutive OFDM symbols (2K) or to two consecutive OFDM symbols (4K).

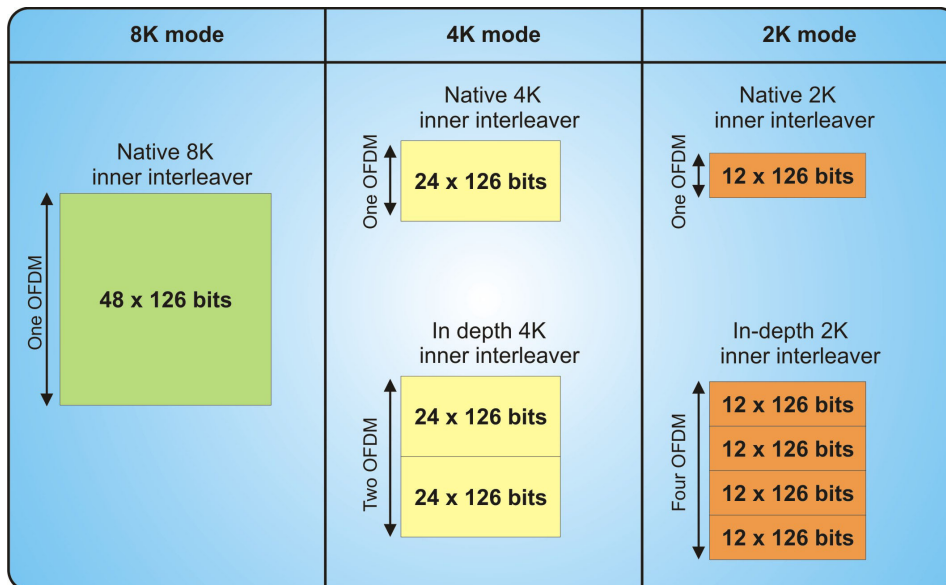

Fig. 6 In-Depth Interleaver for 2K and 4K Mode

Forward Error Correction for Multiprotocol Encapsulated Data (MPE-FEC)

The MPE-FEC module provided with DVB-H improves the carrier-to-noise (C/N) performance and the Doppler performance in mobile channels and improve the tolerance to impulse interference.

This is accomplished by adding an additional Reed-Solomon code (RS 255,191) in conjunction with a block interleaver. The MPE-FEC module provides a specific frame structure; the MPE-FEC frame. The MPE-FEC frame consists of an application data table (ADT) with 191 columns for the IP datagramms and an Reed-Solomon data table (RDT) with 61 columns for the Reed-Solomon parity information.

The IP datagramms are introduced vertically column-by-column. Empty cells and columns are padded with zeros. The RS code is coded line-by-line: For each row of 191 IP datagramm bytes the 64 parity bytes are calculated, using the RS code. This provides a virtual interleaving effect, because all RS data bytes are calculated from the IP datagramms.

After the coding is finished, the IP datagramms are encapsulated and transmitted in an MPE section and the parity information data of each column in the RDT table are transmitted in an MPE-FEC section.

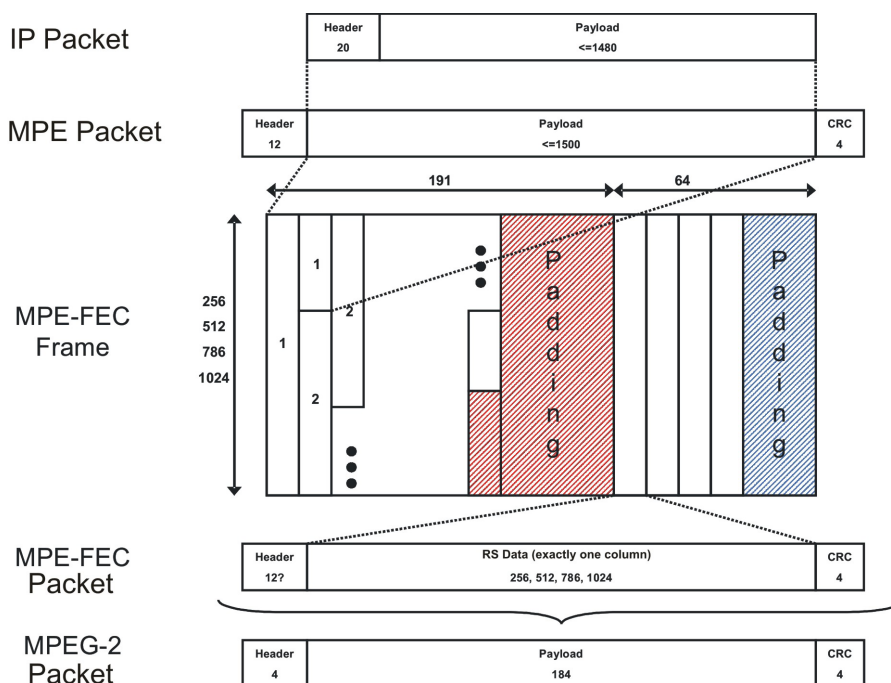

Fig. 9 MPE-FEC Packet/Frame Structure

Transmitting the IP datagramms and parity information data in separate sections allows the receiver to choose whether to use the MPE-FEC feature or not. If the MPE-FEC decoder is not implemented or if the feature is not activated in the receiver, the transmitted MPE-FEC sections with the parity information data are ignored, that is, only the payload with the IP datagramms is taken under consideration.

Note

MPE-FEC is optional for DVB-H.

DVB-H Menu

The menu for setting the DVB-H digital standard is either called from the baseband block or from the menu tree under **Baseband**.

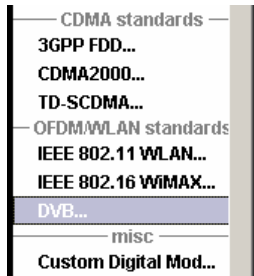

General Settings for DVB-H Signals

The menu is split into several sections for configuring the standard.

The upper menu section is where the DVB-H digital standard is selected, enabled, and reset, and where the generated waveform file can be selected.

In the **Signal Parameters** section, the number of super-frames can be selected and signal relevant parameters are displayed, if a signal is being generated.

The buttons in the lower menu section lead to submenus to configure the system and setting the filter, trigger, and clock parameters.

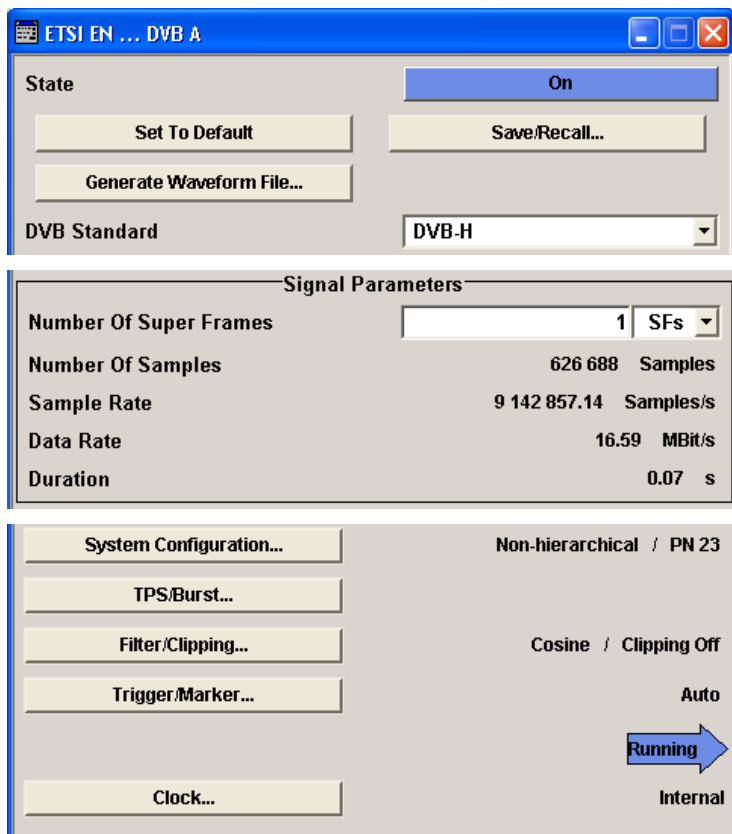

The upper menu section is where the DVB-H digital standard is selected, enabled, and reset and where the generated waveform file can be selected.

State – DVB-H

Activates or deactivates the DVB-H standard.

Activating this standard disables all the other digital standards and digital modulation modes (in case of two-path instruments, this affects the same path).

The DVB-H signal is generated according to the performed settings.

Remote-control command:

SOUR:BB:DVB:STAT ON

Set To Default - DVB-H

Calls the default settings.

Remote-control command:

SOUR:BB:DVB:PRES

Parameter	Value
State	ON
Number of Super-Frames	1
Hierarchy Mode	Non-hierarchical
HP Sorce	PN 23
Filter Type	Cosine
Clipping	OFF
Trigger Mode	Auto
Cell Identification	ON
Time-Slicing	ON
ID [4 hex]	0000
MPE-FEC	OFF
PN Scrambler	ON
Outer Coder	ON
Outer Interleaver	ON
Inner Coder	ON
Rate	1/2
Inner Bit Interleaver	ON
Inner Symbol Interleaver	ON
Inner Interleaver Mode	Native
TX Mode	2 K
OFDM/RF Bandwith	8 MHz
Modulation	QPSK
Alpha	1
Guard Inerval	1/8

Save/Recall... - DVB-H

Calls the **Save/Recall** menu.

From the **Save/Recall** menu, the **File Select** windows for saving and recalling DVB-H configurations and the **File Manager** is called.



DVB-H configurations are stored as files with the predefined file extension ***.dvb**. The file name and the directory they are stored in are user-definable.

The complete settings in the **DVB-H** menu are saved and recalled.

Recall DVB-H Setting

Opens the **File Select** window for loading a saved DVB-H configuration.

The configuration of the selected (highlighted) file is loaded by pressing the **Select** button.

Remote-control command:

```
MMEM:CDIR 'F:\gen_list\dvb'
```

```
SOUR:BB:DVb:SETT:CAT?
```

```
Response: 'dvb_1', 'dvb_2'
```

```
SOUR:BB:DVb:SETT:LOAD "dvb_1"
```

Save DVB-H Setting

Opens the **File Select** window for saving the current DVB-H signal configuration.

The name of the file is specified in the **File name** entry field, the directory selected in the **save into** field. The file is saved by pressing the **Save** button.

Remote-control command:

```
MMEM:CDIR 'F:\gen_list\dvb'
```

```
SOUR:BB:DVb:SETT:STOR "dvb_1"
```

File Manager

Calls the **File Manager**.

The **File Manager** is used to copy, delete, and rename files and to create new directories.

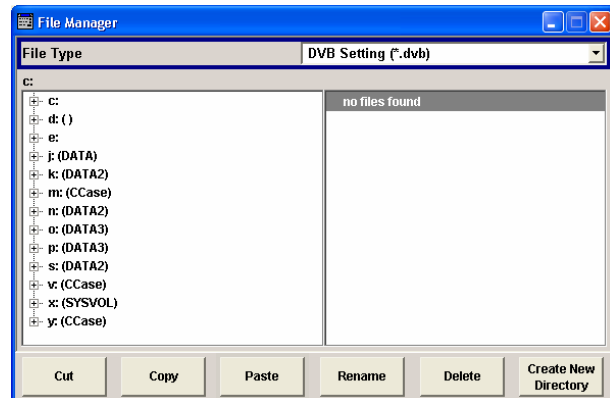

Remote-control command:

```
MMEM:CDIR 'F:\gen_list\Dvb'
```

```
SOUR:BB:DVb:SETT:DEL "Dvb_1"
```

Generate Waveform File... - DVB-H - Calls the **Generate Waveform** menu. This menu is used to store the current DVB-H signal as ARB signal in a waveform file.

This file can be loaded in the **ARB** menu and processed as multicarrier or multisegment signal.

The file name is entered in the submenu. The file is stored with the predefined file extension ***.wv**. The file name and the directory it is stored in are user-definable.

Remote-control command:

SOUR:BB:DVB:WAV:CRE "d:\temp\dvb.wv"

DVB Standard - DVB-H Selects the DVB standard to be used to generate the modulation signal.

Note:

In this release only DVB-H is available.

Remote-control command:

SOUR:BB:DVB:STAN DVBH

In the **Signal Parameters** section, the number of super-frames can be selected and signal relevant parameters are displayed, if a signal is being generated.

Number of Super Frames - DVB-H Sets the number of the transmitted super-frames. Each super-frame consists of four OFDM frames.

Remote-control command:

SOUR:BB:DVB:DVBH|DVBT:SFR 50

Number of Samples - DVB-H Displays the number of the transmitted samples.

Remote-control command:

SOUR:BB:DVB:DVBH|DVBT:SAMP:LENG?

Response: 626688

Sample Rate - DVB-H Displays the sample rate.

Remote-control command:

SOUR:BB:DVB:DVBH|DVBT:SAMP:RATE?

Response: 9142857.1428571437

Data Rate - DVB-H Displays the data rate.

Remote-control command:

SOUR:BB:DVB:DVBH|DVBT:DRAT?

Response: 16.58823529411765

Duration - DVB-H Displays the signal duration.

Remote-control command:

SOUR:BB:DVB:DVBH|DVBT:DUR?

Response: 0.068544

The buttons in the lower menu section lead to submenus to configure the system and setting the filter, trigger, and clock parameters.

- System Configuration... - DVB-H** Calls the **System Configuration** menu for configuring the DVB-H system.
The menu is described in section "[System Configuration - DVB-H](#)", page 14.
Remote-control command: n.a.
- TPS Settings... - DVB-H** Calls the **TPS Settings** menu for setting the TPS parameters and viewing the status of the parameter bits.
The menu is described in section "[TPS Settings](#)", page 17.
Remote-control command: n.a.
- Filtering, Clipping... - DVB-H** Calls the menu for setting baseband filtering and clipping. The current filter and the clipping state are displayed next to the button.
The menu is described in section "[Filtering/Clipping Settings- DVB-H](#)", page 21.
Remote-control command: n.a.
- Trigger - Marker - DVB-H** **(Trigger for R&S SMx and R&S AMU instruments only)**
Calls the menu for selecting the trigger mode and trigger source, for configuring the marker signals, and for setting the time delay of an external trigger signal.
This menu is described in section "[Trigger-Marker-Clock - DVB-H](#)", page 25.
The currently selected trigger mode and trigger source are displayed next to the button.
Remote-control command: n.a.
- Execute Trigger - DVB-H** **(R&S SMx and R&S AMU instruments only)**
Executes the trigger manually.
A manual trigger can be executed only if an internal trigger source and a trigger mode other than **Auto** have been selected.
Remote-control command:
SOUR : BB : DVB : TRIG : EXEC
- Arm - DVB-H** **(R&S SMx and R&S AMU instruments only)**
Stops signal generation manually.
The **Arm** button is displayed only if the trigger modes **Armed Retrigger** or **Armed Auto** have been selected.
Remote-control command:
SOUR : BB : DVB : TRIG : ARM : EXEC

Clock - DVB-H**(R&S SMx and R&S AMU instruments only)**

Calls the menu for selecting the clock source and for setting a delay.

This menu is described in section "[Trigger-Marker-Clock - DVB-H](#)", page 25.

Remote-control command: n.a.

System Configuration - DVB-H

The **System Configuration** menu allows to configure the DVB system. The DVB system is displayed in form of a block diagram including all parameters necessary to configure the system.

The system diagram depends on the hierarchy mode which is selected in the **Hierarchy Mode** field.

Note:

In this release only the non-hierarchical mode is available.

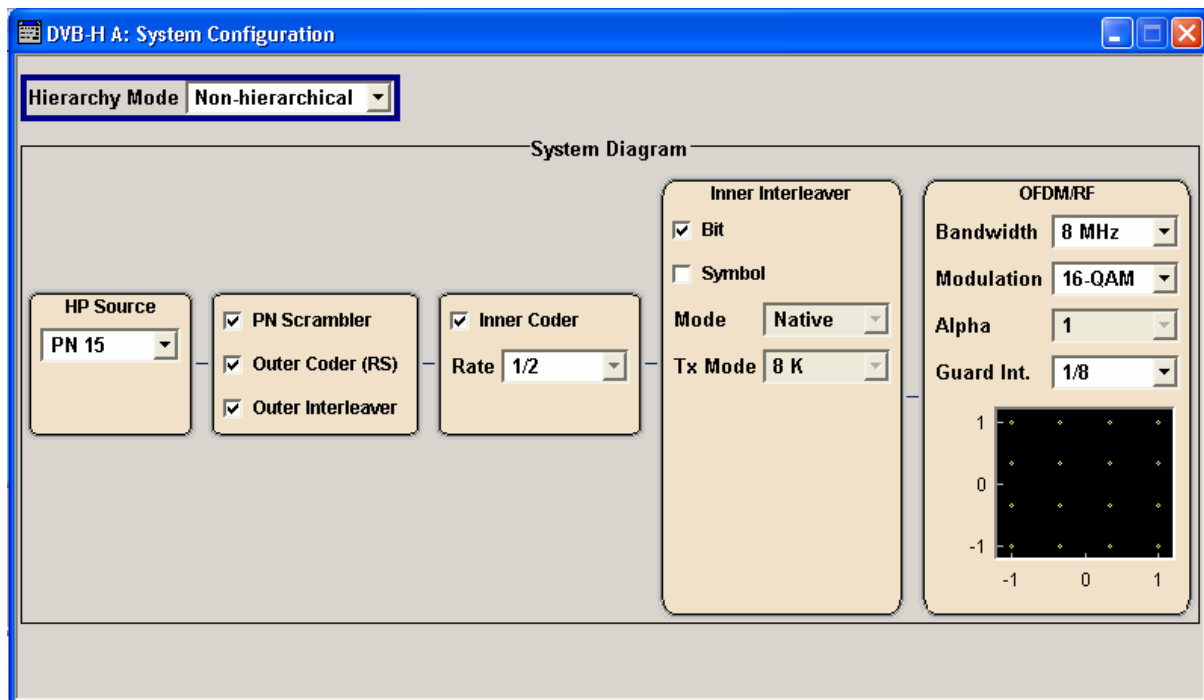
**Hierarchy Mode - DVB-H**

Selects the hierarchy mode.

Note:

In this release only the non-hierarchical mode is available.

Hierarchical

Both inputs are used. The inputs are identical and simply differ in the prioritization.

Remote-control command:

SOUR:BB:DVB:DVBH|DVBT:HMOD HIER

Non-hierarchical

Only the high priority input is used.

Remote-control command:

SOUR:BB:DVB:DVBH|DVBT:HMOD NHI

HP/LP Source - DVB-H	<p>Selects the data source.</p> <p>Remote-control command: <code>SOUR:BB:DVB:DVBH DVBT:HP LP:DATA DLIS</code></p> <p><code>MMEM:CDIR 'D:\Lists\DVB\TestData'</code></p> <p><code>BB:DVB:DVBH:HP:DATA:DSEL 'dvh_1'</code></p>
PN Scrambler - DVB-H	<p>Activates/deactivates the PN scrambling. The data packets of the incoming transport stream are transformed to a Pseudo Random Binary Sequence (PRBS) in order to obtain a bit sequence that has a positive effect on the transmitted RF spectrum.</p> <p>For details, refer to section "Pseudo Noise Scrambler", page 2.</p> <p>Remote-control command: <code>SOUR:BB:DVB:DVBH DVBT:HP LP:PNSC:STAT ON</code></p>
Outer Coder (RS) - DVB-H	<p>Activates/deactivates the outer coder. The outer coder applies a Reed-Solomon error correction code to the PRBS data stream. For details, refer to section "Outer Coder", page 2.</p> <p>Remote-control command: <code>SOUR:BB:DVB:DVBH DVBT:HP LP:OCOD:STAT ON</code></p>
Outer Interleaver - DVB-H	<p>Activates/deactivates the outer convolutional interleaver. For details, refer to section "Outer Interleaver", page 2.</p> <p>Remote-control command: <code>SOUR:BB:DVB:DVBH DVBT:HP LP:OINT:STAT ON</code></p>
Inner Coder - DVB-H	<p>Activates/deactivates the inner coder. The inner coder is a punctured convolutional error-correcting coder. For details, refer to section "Inner Coder", page 3.</p> <p>Remote-control command: <code>SOUR:BB:DVB:DVBH DVBT:HP LP:ICOD:STAT ON</code></p>
Rate - DVB-H	<p>Selects the code rate of the inner coder. A number of incoming bits (m) to be encoded is transformed into an bit symbol (containing n-bits), where m/n is the code rate. For details, refer to section "Inner Coder", page 3.</p> <hr/> <p>Note: <i>This field is available only if the inner code state is set to active.</i></p> <hr/> <p>Remote-control command: <code>SOUR:BB:DVB:DVBH DVBT:HP LP:ICOD:RATE CR1D2</code></p>
Inner Bit Interleaver - DVB-H	<p>Activates/deactivates the inner bit interleaver. For details, refer to section "Inner Interleaver", page 4.</p> <p>Remote-control command: <code>SOUR:BB:DVB:DVBH DVBT:IINT:BIT:STAT ON</code></p>

Inner Symbol Interleaver - DVB-H	<p>Activates/deactivates the inner symbol interleaver. For details, refer to section "Inner Interleaver", page 4.</p> <hr/> <p>Note: <i>If the symbol interleaver is deactivated, selecting the interleaver mode and the transmission mode is not possible.</i></p> <hr/> <p>Remote-control command: SOUR : BB : DVB : DVBH DVBT : I INT : SYMB : STAT ON</p>
Inner Interleaver Mode - DVB-H	<p>Selects the inner interleaver mode. Interleaver mode In-depth is available only for transmission mode 2K and 4K. For details, refer to section "Inner Interleaver", page 4.</p> <p>Remote-control command: SOUR : BB : DVB : DVBH DVBT : I INT : SYMB : MODE NAT</p>
Inner Interleaver Tx Mode - DVB-H	<p>Selects the transmission mode. This setting determines the number of the OFDM subcarriers. For transmission mode 8K, the in-depth interleaver mode is not available. For details, refer to section "Inner Interleaver", 4 page.</p> <hr/> <p>Note: <i>Transmission mode 4K is only available for DVB-H.</i></p> <hr/> <p>Remote-control command: SOUR : BB : DVB : DVBH DVBT : I INT : SYMB : TMOD T2K</p>
OFDM/RF Bandwith - DVB-H	<p>Selects the system bandwidth.</p> <p>Remote-control command: SOUR : BB : DVB : DVBH DVBT : OFDM : BWID 5</p>
OFDM/RF Modulation - DVB-H	<p>Selects the constellation for the OFDM modulation. For details, refer to section "Mapper", page 4.</p> <p>Remote-control command: SOUR : BB : DVB : DVBH DVBT : OFDM : MOD QPSK</p>
OFDM/RF Alpha - DVB-H	<p>Selects the alpha value. This value is used to shape the constellation of the modulation. For non-hierarchical mode, this value is always 1 and can not be changed. For details, refer to section "Mapper", page 4.</p> <hr/> <p>Note: <i>The values in the list are selectable only if Hierarchical is selected in the Hierarchy Mode field and a modulation type other than QPSK is selected. In this release only the Non-hierarchical mode is available.</i></p> <hr/> <p>Remote-control command: SOUR : BB : DVB : DVBH DVBT : OFDM : ALPH 2</p>

OFDM/RF Guard Int - DVB-H

Selects the value for the guard interval. The guard interval extends the length of the transmitted symbol. The guard intervals are given as fractions of a symbol period.

Remote-control command:

```
SOUR:BB:DVB:DVBH|DVBT:OFDM:GINT G11D8
```

TPS Settings

The **TPS Settings** menu allows to select the bits to transmit via the TPS signal and displays the status of the parameter bits.

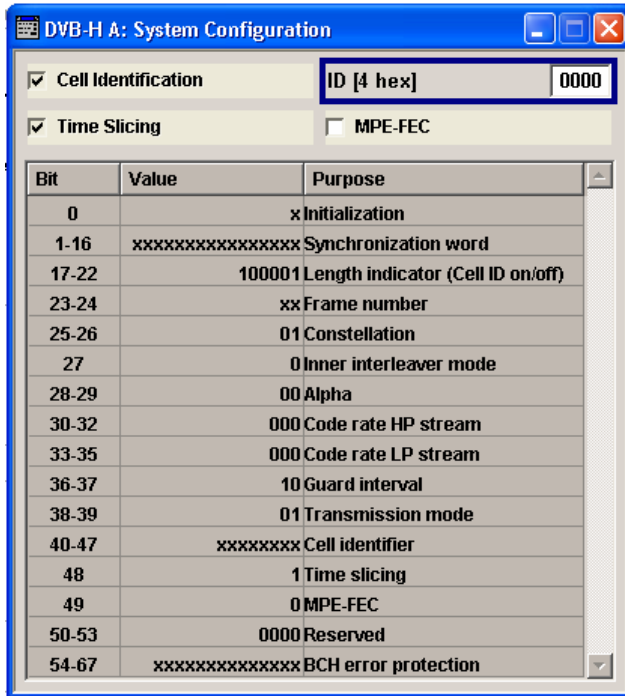

Cell Identification - DVB-H

Activates/deactivates the TPS cell identification. If activated, the cell from which the signal comes from is identified.

Remote-control command:

```
SOUR:BB:DVB:DVBH|DVBT:TPS:ID:STAT ON
```

ID [4 hex] - DVB-H

Sets the cell ID for cell identification. The cell ID identifies the cell from which the signal is transmitted. This value is read by the receiver only if **Cell Identification** is activated.

Remote-control command:

```
SOUR:BB:DVB:DVBH|DVBT:TPS:ID:PATT 0000
```

Time Slicing - DVB-H

Activates/deactivates the time-slicing bit. If activated, the average power consumption of the terminal is reduced. Time-slicing information has to be included in the transport stream and is not generated by this application.

For details, refer to section "[Time-Slicing](#)", page 7.

Remote-control command:

SOUR : BB : DVB : DVBH | DVBT : TPS : TSL : STAT ON

MPE FEC - DVB-H

Activates/deactivates the multiprotocol encapsulation forward error correction bit. MPE-FEC must be performed in the transport stream and is not provided by this application.

For details, refer to section "[Forward Error Correction for Multiprotocol Encapsulated Data \(MPE-FEC\)](#)", page 8.

Remote-control command:

SOUR : BB : DVB : DVBH | DVBT : TPS : MFEC : STAT ON

TPS Table - DVB-H

The TPS parameter bit table displays the status of the transmitted TPS parameter bits.

Bit	Value	Purpose
0	x	Initialization
1-16	xxxxxxxxxxxxxxxx	Synchronization word
17-22	100001	Length indicator (Cell ID on/off)
23-24	xx	Frame number
25-26	10	Constellation
27	0	Inner interleaver mode
28-29	00	Alpha
30-32	000	Code rate HP stream
33-35	000	Code rate LP stream
36-37	10	Guard interval
38-39	01	Transmission mode
40-47	xxxxxxx	Cell identifier
48	1	Time slicing
49	1	MPE-FEC
50-53	0000	Reserved
54-67	xxxxxxxxxxxx	BCH error protection

For DVB-H, the following TPS signalling information is transmitted:

Bit number	Format	Purpose
0	0	Initialization bit for the differential 2-PSK modulation. The modulation of the TPS initialization bit is derived from the PRBS sequence.
	1	
1-16		Bits 1 to 16 of the TPS are the synchronization words for the TPS blocks in the super-frames:
	0011010111101110	Synchronization word for the first and the third TPS block in each super-frame
	11001010000100001	Synchronization word for the second and the fourth TPS block in each super-frame
17-22		The first 6 bits of the TPS information is used as a TPS length indicator to signal the number of used bits of the TPS:
	010111	Cell Identification is not transmitted (23 TPS bits in use)
	011111	Cell Identification information is transmitted (31 TPS bits in use)
	100001	Cell Identification information is transmitted for DVB-H (33 TPS bits in use)
23-24		Indicates the frame in the super-frame. Four frames constitute a super-frame.
	00	Frame 1 in the super-frame
	01	Frame 2 in the super-frame
	10	Frame 3 in the super-frame
25-26		Indicates the constellation
	00	QPSK
	01	16-QAM
	10	64-QAM
27		Indicates the interleaver mode. The in-depth interleaver can be used for 2K and 4K transmission mode. For transmission mode 8K, only the native interleaver shall be used:
	0	The native interleaver is used
	1	The in-depth interleaver is used
28-29		Indicates the hierarchical transmission and the value of the Alpha-factor
	00	Transmission in non-hierarchical mode
	01	Alpha = 1
	10	Alpha = 2
30-32		Indicates the code rate for the HP transmission stream
	000	1/2
	001	2/3
	010	3/4
	011	5/6
	100	7/8
	101	Reserved
110	Reserved	
33-35		Indicates the code rate for the LP transmission stream
	000	1/2
	001	2/3
	010	3/4
	011	5/6
	100	7/8

Bit number	Format	Purpose
	101	Reserved
	110	reserved
	111	reserved
36-37		Indicates the value for the guard interval
	00	1/32
	01	1/16
	10	1/8
	11	1/4
38-39		Indicates the transmission mode
	00	2K mode
	01	8K mode
	10	4K mode
	11	reserved
40-47	Cell_id	32 bits are used for the cell ID. Every frame contains eight bits. The eight bits are used to identify the cell from which the signal comes from.
48		Indicates the usage of time-slicing
	0	Time-slicing is not used
	1	At least one elementary stream uses time-slicing
49		Indicates the usage of MPE-FEC
	0	MPE-FEC is not used
	1	At least one elementary stream uses MPE-FEC
50-53	reserved	
54-67	xxxxxxxxxxxxxxxx	BCH Error Protection

Filtering/Clipping Settings- DVB-H

The **Filter/Clipping Settings** menu is reached via the **DVB-H** main menu.

The filter parameters (**Filter** section) and the clipping (**Clipping** section) are defined in this menu. "

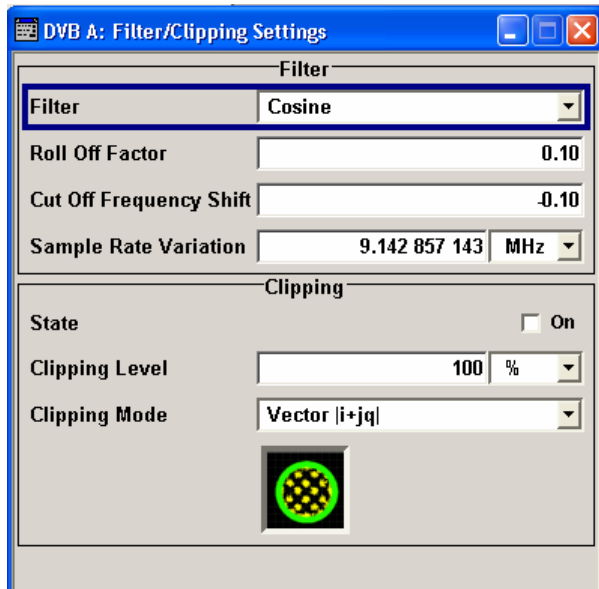

In the **Filter** section, the settings are made for the baseband filter.

Filter - DVB-H

Selects the baseband filter.

This opens a selection window containing all the filters available to the instrument.

Remote-control command:

```
SOUR:BB:DVB:FILT:TYPE RCOS
```

Roll Off Factor or BxT - DVB-H

Enters the filter parameters.

The filter parameter offered (**Roll Off Factor** or **BxT**) depends on the currently selected filter type. This parameter is always set to the default for each of the predefined filters.

Remote-control commands:

```
SOUR:BB:DVB:FILT:PAR:APCO25 0.2
SOUR:BB:DVB:FILT:PAR:COS 0.10
SOUR:BB:DVB:FILT:PAR:GAUS 0.5
SOUR:BB:DVB:FILT:PAR:PGA 0.5
SOUR:BB:DVB:FILT:PAR:RCOS 0.35
SOUR:BB:DVB:FILT:PAR:SPH 2
```

Cut Off Frequency Shift - DVB-H

(This feature is available for filter parameter Cosine only)

Sets the value for the cut off frequency shift. The cut off frequency of the cosine filter can be adjusted to reach spectrum mask requirements.

Remote-control command:

```
SOUR:BB:DVB:FILT:PAR:COS:COFS 1.0
```

- Cut Off Frequency Factor - DVB-H** (This feature is available for filter parameter Lowpass only.)
Sets the value for the cut off frequency factor. The cut off frequency of the lowpass filter can be adjusted to reach spectrum mask requirements.
Remote-control command:
SOUR:BB:DVB:FILT:PAR:LPAS 0.5
- Sample Rate Variation - DVB-H**
Sets the sample rate variation.
A variation of this parameter only affects the ARB clock rate, all other signal parameters remain unchanged. If the sampling rate in the frame configuration menu is changed, this parameter is reset to the chosen sampling rate.
Remote-control command:
SOUR:BB:DVB:SRAT:VAR 40000000
- Impulse Length - DVB-H** (For R&S WinIQSIM2 only)
Displays the number of filter tabs. If the check box is activated, the most sensible parameter values are selected. The value depends on the coherence check. If the check box is deactivated, the values can be changed manually.
Remote-control command:
SOUR:BB:DVB:FILT:ILEN:AUTO ON
SOUR:BB:DVB:FILT:ILEN 120
- Oversampling - DVB-H** (For R&S WinIQSIM2 only)
Determines the upsampling factor. If the check box is activated, the most sensible parameter values are selected. The value depends on the coherence check. If the check box is deactivated, the values can be changed manually.
Remote-control command:
SOUR:BB:DVB:FILT:OSAM:AUTO ON
SOUR:BB:DVB:FILT:OSAM 20

The settings for clipping are collected in the **Clipping** section.

Clipping State – DVB-H

Activates or deactivates the baseband clipping.

Baseband clipping is a very simple and effective way of reducing the crest factor of the DVB-H signal.

DVB-H signals may have a quite high crest factor ($\sim 11\text{dBm}$) because of high amplitude variations that come along with OFDM signals having a noise-like spectrum. High crest factors entail two basic problems:

- The nonlinearity of the power amplifier (compression) causes intermodulation which expands the spectrum (spectral regrowth).
- Since the level in the D/A converter is relative to the maximum value, the average value is converted with a relatively low resolution. This results in a high quantization noise.

Both effects increase the adjacent-channel power.

With baseband clipping, all the levels are limited to a settable value (**Clipping Level**). This level is specified as a percentage of the highest peak value. Since clipping is done prior to filtering, the procedure does not influence the spectrum. The EVM however increases.

Since clipping the signal not only changes the peak value but also the average value, the effect on the crest factor is unpredictable. The following table shows the effect of the **Clipping** on the crest factor for typical scenarios.

Remote-control command:

```
SOUR:BB:DVB:CLIP:STAT ON
```

The following pictures demonstrate the affect of clipping with vector mode ($|i+jq|$), using the default signal configuration with a PN23 input sequence.

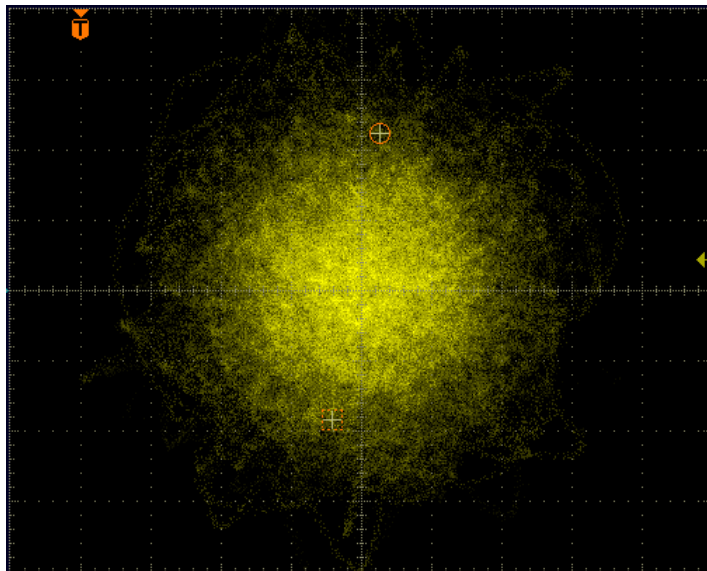

Fig. 10 Constellation diagram of the signal without clipping, shows the level mapping

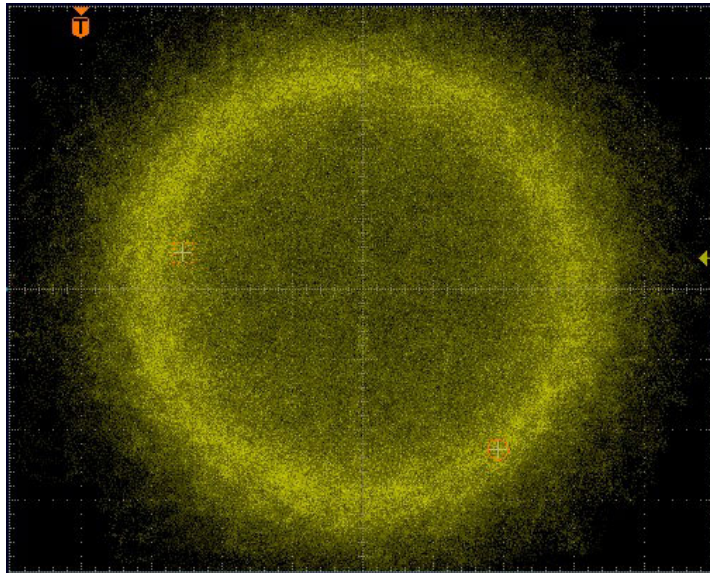

Fig. 11 Constellation diagram with clipping level 10 %, vector mode ($|i+jq|$).

Clipping Level- DVB-H

Enters the limit for clipping.

This value indicates at what point the signal is clipped. It is specified as a percentage, relative to the highest level. 100% indicates that clipping does not take place.

Remote-control command:

SOUR:BB:DVB:CLIP:LEV 50

Clipping Mode - DVB-H

Selects the clipping method. A graphic illustration of the way in which these two methods work is given in the menu.

Vector $|i + jq|$

The limit is related to the amplitude $|i + jq|$. The I and Q components are mapped together, the angle is retained (see also figures above, Clipping State).

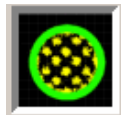

Remote-control command:

SOUR:BB:DVB:CLIP:MODE VECT

Scalar $|i|, |q|$

The limit is related to the absolute maximum of all the I and Q values $|i|, |q|$.

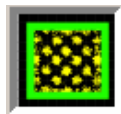

The I and Q components are mapped separately, the angle changes.

Remote-control command:

SOUR:BB:DVB:CLIP:MODE SCAL

Trigger-Marker-Clock - DVB-H

Note:

The trigger, clock, and marker delay functions are available for R&S SMx and R&S AMU instruments only.

The **Trigger/Marker/Clock** menu can be reached via the **DVB-H** main menu.

The **Trigger In** section is where the trigger for the DVB-H signal is set. Various parameters are provided for the settings, depending on which trigger source - internal or external - is selected. The current status of signal generation (**Running** or **Stopped**) is indicated for all trigger modes.

The **Marker Mode** section is where the marker signals at the MARKER output connectors are configured.

The **Marker Delay** section is where the marker signal delay is defined, either without restriction or restricted to the dynamic section, i.e., the section in which it is possible to make settings without restarting signal and marker generation.

The **Clock Settings** section is where the clock source is selected and - in the case of an external source - the clock type.

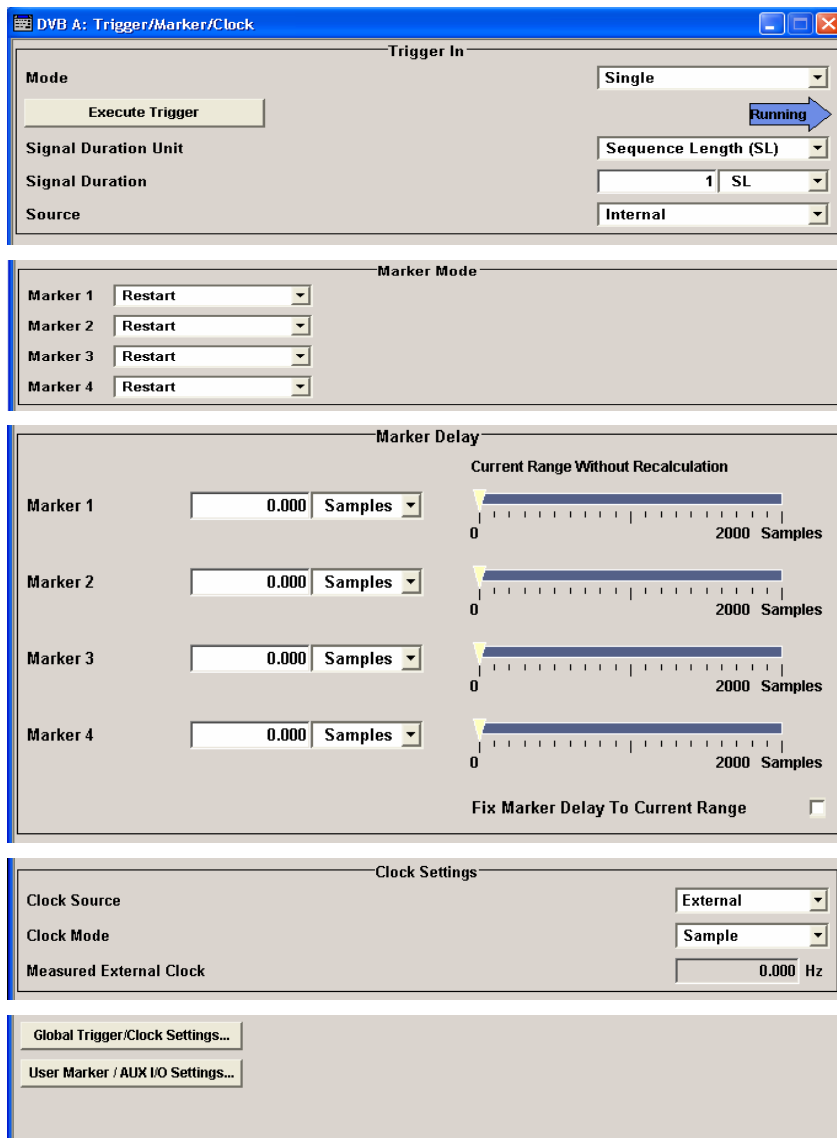

The **Trigger In** section is where the trigger for the DVB-H signal is set. The current status of the signal generation is displayed for all trigger modes.

Mode - DVB-H**(R&S SMx and R&S AMU instruments only)**

Selects the trigger mode.

The trigger mode determines the effect of a trigger on the signal generation.

Auto	The DVB-H signal is generated continuously. Remote-control command: SOUR:BB:DVB:SEQ AUTO
Retrigger	The DVB-H signal is generated continuously. A trigger event (internal or external) causes a restart. Remote-control command: SOUR:BB:DVB:SEQ RETR
Armed Auto	The DVB-H signal is generated only when a trigger event occurs. Then the signal is generated continuously. Clicking the button Arm stops signal generation. A subsequent trigger event (internal with Execute Trigger or external) causes a restart. Remote-control command: SOUR:BB:DVB:SEQ AAUT
Armed Retrigger	The DVB-H signal is generated only when a trigger event occurs. Then the signal is generated continuously. Every subsequent trigger event causes a restart. Clicking the button Arm stops signal generation. A subsequent trigger event (internal with Execute Trigger or external) causes a restart. Remote-control command: SOUR:BB:DVB:SEQ ARET
Single	The DVB-H signal is generated only when a trigger event occurs. Then the signal is generated once to the length specified at Signal Duration . Every subsequent trigger event (internal with Execute Trigger or external) causes a restart. Remote-control command: SOUR:BB:DVB:SEQ SING

Signal Duration Unit - DVB-H**(R&S SMx and R&S AMU instruments only)**

Selects the unit for the entry of the length of the signal sequence to be output in the **Single** trigger mode. Available units are sequence length (SL) or frames.

Remote-control command:
SOUR:BB:DVB:TRIG:SLUN FRAM

Signal Duration - DVB-H**(R&S SMx and R&S AMU instruments only)**

Enters the length of the signal sequence to be output in the **Single** trigger mode. The unit of the entry is defined under **Signal Duration Unit**. It is possible to output deliberately just part of the super-frame, an exact sequence of frames, or a defined number of repetitions of the sequence length.

Remote-control command:

SOUR:BB:DVB:TRIG:SLEN 2000

Running - Stopped - DVB-H**(R&S SMx and R&S AMU instruments only)**

Displays the status of signal generation for all trigger modes. This display appears only when DVB-H is enabled (**State On**).

Remote-control command:

SOUR:BB:DVB:TRIG:RMOD?

Response: RUN

Running

The DVB-H modulation signal is generated; a trigger was (internally or externally) initiated in triggered mode.

If **Armed Auto** or **Armed Retrigger** have been selected, generation of signals can be stopped with the **Arm** button. A new trigger (internally with **Execute Trigger** or externally) causes a restart.

Stopped

The signal is not generated and the instrument waits for a trigger event (internal or external).

Arm - DVB-H**(R&S SMx and R&S AMU instruments only)**

Stops signal generation. This button appears only with **Running** signal generation in the **Armed Auto** and **Armed Retrigger** trigger modes.

Signal generation can be restarted by a new trigger (internally with **Execute Trigger** or externally).

Remote-control command:

SOUR:BB:DVB:TRIG:ARM:EXEC

Execute Trigger - DVB-H**(R&S SMx and R&S AMU instruments only)**

Executes trigger manually. A manual trigger can be executed only when an internal trigger source and a trigger mode other than **Auto** have been selected.

Remote-control commands:

SOUR:BB:DVB:TRIG:SOUR INT

SOUR:BB:DVB:SEQ RETR

SOUR:BB:DVB:TRIG:EXEC

Trigger Source - DVB-H

(R&S SMx and R&S AMU instruments only)

Selects trigger source. This setting is effective only when a trigger mode other than **Auto** has been selected.

Internal

The trigger event is executed by **Execute Trigger**.

Remote-control command:

SOUR:BB:DVB:TRIG:SOUR INT

Internal (Baseband A/B)

The trigger event is executed by the trigger signal from the second path (two-path instruments only).

Remote-control command:

SOUR:BB:DVB:TRIG:SOUR OBAS

External (TRIGGER 1 / 2)

The trigger event is executed with the aid of the active edge of an external trigger signal. The trigger signal is supplied via the TRIGGER 1 or TRIGGER 2 connector.

The polarity, the trigger threshold, and the input impedance of the TRIGGER input can be set in the **Global Trigger/Clock Settings** menu.

Remote-control command:

SOUR:BB:DVB:TRIG:SOUR EXT|BEXT

Trigger Delay - DVB-H

(R&S SMx and R&S AMU instruments only)

Sets the trigger signal delay in samples on external triggering (or on internal triggering via the second path for two-path instruments).

This enables the R&S Signal Generator to be synchronized with the device under test or other external devices.

Note:

For two-path instruments, the delay can be set separately for each of the two paths.

Remote-control command:

SOUR:BB:DVB:TRIG:EXT:DEL 3

SOUR:BB:DVB:TRIG:OBAS:DEL 3

Trigger Inhibit - DVB-H (R&S SMx and R&S AMU instruments only)

Sets the duration for inhibiting a new trigger event subsequent to triggering. The input is to be expressed in samples.

In the **Retrigger** mode, every trigger signal causes signal generation to restart. This restart is inhibited for the specified number of samples.

This parameter is only available on external triggering (or on internal triggering via the second path for two-path instruments).

Note:

For two-path instruments, the trigger inhibit can be set separately for each of the two paths.

Remote-control command:

```
SOUR:BB:DVB:TRIG:EXT1:INH 1000
```

```
SOUR:BB:DVB:TRIG:OBAS:INH 1000
```

The marker output signal for synchronizing external instruments is configured in the **Marker Settings** section **Marker Mode**.

Marker Mode - DVB-H Selects a marker signal for the associated MARKER output.

Restart A marker signal is generated at the start of every sequence length loop.

Remote-control command:

```
SOUR:BB:DVB:TRIG:OUTP1:MODE REST
```

Super Frame Start A marker signal is generated at the start of every super-frame period.

Remote-control command:

```
SOUR:BB:DVB:TRIG:OUTP1:MODE SFR
```

Frame Start A marker signal is generated at the start of every frame.

Remote-control command:

```
SOUR:BB:DVB:TRIG:OUTP1:MODE FRAM
```

Pulse A marker pulse is generated continuously according to the frequency and frequency divider.

Remote-control command:

```
SOUR:BB:DVB:TRIG:OUTP1:MODE PULS
```

Pattern A marker signal is generated due to a bit pattern given by the user. Each bit represents a sample and can be switched on or off.

Remote-control command:

```
SOUR:BB:DVB:TRIG:OUTP1:MODE PATT
```

On/Off Ratio

A regular marker signal that is defined by an ON/OFF ratio is generated. A period lasts one ON and OFF cycle.

Start of signal

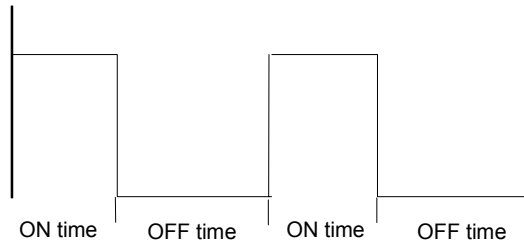

The ON time and OFF time are each expressed as a number of samples and are set in an input field which opens when **On/Off Ratio** is selected.

On Time	<input type="text" value="1"/>	Samples ▾
Off Time	<input type="text" value="1"/>	Samples ▾

Remote-control commands:

```
SOUR:BB:DVB:TRIG:OUTP1:MODE RAT
SOUR:BB:DVB:TRIG:OUTP1:OFFT 200
SOUR:BB:DVB:TRIG:OUTP1:ONT 200
```

Divider - DVB-H

(This field is available for marker mode Pulse only)

Sets the divider for the pulsed marker signal in the setting pulse mode. The pulse frequency is derived by dividing the symbol rate by the divider.

Remote-control command:

```
SOUR:BB:DVB:TRIG:OUTP1:PULS:DIV 2
```

Frequency - DVB-H

(This field is available for marker mode Pulse only)

Displays the pulse frequency of the pulsed marker signal. The pulse frequency is derived by dividing the symbol rate by the divider.

Remote-control command:

```
SOUR:BB:DVB:TRIG:OUTP1:PULS:FREQ?
```

Pattern - DVB-H

(This field is available for marker mode Pattern only)

Sets the bit pattern used to generate the marker signal.

Remote-control command:

```
SOUR:BB:DVB:TRIG:OUTP1:PATT ##H39FE0000,32
```

The **Marker Delay** section can be used to set a delay for the markers.

Note:

The marker delay functions are available for R&S SMx and R&S AMU instruments only.

Marker Delay - DVB-H**(R&S SMx and R&S AMU instruments only)**

Enters the delay between the marker signal at the marker outputs and the start of the signal.

The input is expressed as a number of samples.

If the setting "**Fix Marker Delay to Current range**" is enabled, the setting range is restricted to the dynamic range. In this range, the delay of the marker signals can be set without restarting the marker and signal.

Remote-control command:

SOUR:BB:DVB:TRIG:OUTP2:DEL 2

Current Range without Recalculation- DVB-H**(R&S SMx and R&S AMU instruments only)**

Displays the current range within which the delay of the marker signals can be set without restarting the marker and signal.

Remote-control command

SOUR:BB:DVB:TRIG:OUTP2:DEL:MAX?

SOUR:BB:DVB:TRIG:OUTP2:DEL:MIN?

Fix Marker Delay To Current Range - DVB-H**(R&S SMx and R&S AMU instruments only)**

Restricts the marker delay setting range to the current range. In this range, the delay can be set without restarting the marker and signal.

Remote-control command:

SOUR:BB:DVB:TRIG:OUTP:DEL:FIX ON

The clock source is selected in the **Clock Settings** section.

Note:

The clock functions are available for R&S SMx and R&S AMU instruments only.

Clock Source - DVB-H**(R&S SMx and R&S AMU instruments only)**

Selects the clock source.

Internal

The internal clock reference is used to generate the sample clock.

Remote-control command:

SOUR:BB:DVB:CLOC:SOUR INT

External The external clock reference is fed in as the sample clock or multiple thereof via the CLOCK connector.

The sample rate must be correctly set to an accuracy of $\pm 2\%$ (see data sheet).

The polarity of the clock input can be changed with the aid of **Global Trigger/Clock Settings**.

Remote-control command:
SOUR : BB : DVB : CLOC : SOUR EXT

Clock Mode - DVB-H**(R&S SMx and R&S AMU instruments only)****(This feature is available for the external clock source only)**

Selects the type of externally supplied clock.

Sample A sample clock is supplied via the CLOCK connector.

Remote-control command:
SOUR : BB : DVB : CLOC : MODE SAMP

Multiple Sample A multiple of the sample clock is supplied via the CLOCK connector. The sample clock is derived internally from this. The value range is 1 to 64.

The **Clock Multiplier** field provided allows the multiplication factor to be entered.

Remote-control command:
SOUR : DVB : CLOC : MODE MSAM

Clock Multiplier - DVB-H**(R&S SMx and R&S AMU instruments only)****(This feature is available for the external clock source only)**Enters the multiplication factor for clock type **Multiple Sample**.

Remote-control command:
SOUR : BB : DVB : CLOC : MULT 4

Measured External Clock - DVB-H**(R&S SMx and R&S AMU instruments only)****(This feature is available for the external clock source only)**

Displays the measured frequency of the external clock signal. This enables the user to permanently monitor the frequency of the externally introduced clock.

This information is displayed only if the external clock source has been selected.

Remote-control command:
CLOC : INP : FREQ?

**Global Trigger/Clock
Settings - DVB-H****(R&S SMx and R&S AMU instruments only)**

Calls the **Global Trigger/Clock/Input Settings** menu. This menu is used among other things for setting the trigger threshold, the input impedance and the polarity of the trigger inputs TRIGGER 1/2.

In the case of two-path instruments, these settings are valid for both paths.

The parameters in this menu affect all digital modulations and standards, and are described in the section "[Global Trigger/Clock/Input Settings – Setup -Environment](#)".

Remote-control command: n.a.

**User Marker/AUX I/O
Settings – DVB-H****(R&S SMx and R&S AMU instruments only)**

Calls the **User Marker/AUX I/O** menu. This menu is used for mapping configuration.

The parameters in this menu affect all digital modulations and standards, and are described in the section "[Global Trigger/Clock/Input Settings – Setup -Environment](#)".

Remote-control command: n.a.

SOURce:BB:DVB-H-Subsystem- Remote-Control Commands

General Commands

The commands in the SOURce:BB:DVB subsystem are described in three sections, separated into general remote commands, commands for system configuration, and commands for the TPS settings.

This subsystem contains commands for the primary and general settings of the DVB-H standard. These settings concern activation and deactivation of the standard, filter, clock, trigger, and clipping settings.

The commands for setting the system configuration and the TPS parameter bits are described in a separate section.

The numerical suffix at SOURce distinguishes between path A and path B for two-path instruments:

SOURce<1> = path A

SOURce<2> = path B

For two-path instruments, the keyword SOURce is optional with commands for path A and can be omitted. For path B, the command must include the keyword with the suffix 2.

For one-path instruments, the keyword SOURce is optional and can be omitted.

Command	Parameter	Default Unit	Comments
[SOURce<[1] 2>:]BB:DVB:CLIPping:LEVel	1...100	PCT	
[SOURce<[1] 2>:]BB:DVB:CLIPping:MODE	VECTor SCALar		
[SOURce<[1] 2>:]BB:DVB:CLIPping:STATe	ON OFF		
[SOURce<[1] 2>:]BB:DVB:CLOCK:MODE	SAMP MSAMP		
[SOURce<[1] 2>:]BB:DVB:CLOCK:MULTIplier	1... 64		
[SOURce<[1] 2>:]BB:DVB:CLOCK:SOURce	EXTernal INTernal		
[SOURce<[1] 2>:]BB:DVB:DVBH DVBT:DRATe			Query only
[SOURce<[1] 2>:]BB:DVB:DVBH DVBT:DURation			Query only
[SOURce<[1] 2>:]BB:DVB:DVBH DVBT:SAMPle:LENGth			Query only
[SOURce<[1] 2>:]BB:DVB:DVBH DVBT:SAMPle:RATE			Query only
[SOURce<[1] 2>:]BB:DVB:DVBH DVBT:SFRames	1...100		
[SOURce<[1] 2>:]BB:DVB:FiLTer:ILENGth	1...128		
[SOURce<[1] 2>:]BB:DVB:FiLTer:ILENGth:AUTO	ON OFF		
[SOURce<[1] 2>:]BB:DVB:FiLTer:OSAMpling	1...32		
[SOURce<[1] 2>:]BB:DVB:FiLTer:OSAMpling:AUTO	ON OFF		
[SOURce<[1] 2>:]BB:DVB:FiLTer:PARAmeter:APCO25	0.05 ... 0.99		
[SOURce<[1] 2>:]BB:DVB:FiLTer:PARAmeter:COSSine	0.05 ... 0.99		
[SOURce<[1] 2>:]BB:DVB:FiLTer:PARAmeter:COSSine:COFS	-1.0...1.0		
[SOURce<[1] 2>:]BB:DVB:FiLTer:PARAmeter:GAUSSs	0.15 ... 2.50		
[SOURce<[1] 2>:]BB:DVB:FiLTer:PARAmeter:LPASSs	0.05 ... 2.0		
[SOURce<[1] 2>:]BB:DVB:FiLTer:PARAmeter:PGAus	0.15 ... 2.5		

Command	Parameter	Default Unit	Comments
[SOURce<[1]2>:]BB:DVB:FiLTer:PARAmeter:RCOSine	0.05 ... 0.99		
[SOURce<[1]2>:]BB:DVB:FiLTer:PARAmeter:SPHase	0.15 ... 2.5		
[SOURce<[1]2>:]BB:DVB:FiLTer:TYPE	RCOSine COSine GAUSS LGAuss PGAuss CONE COF705 LPASs COEQualizer COFequalizer C2K3x APCO25 SPHase EWPSHape RECTangle DIRac ENPSHape		
[SOURce<[1]2>:]BB:DVB:PRESet			No query
[SOURce<[1]2>:]BB:DVB:SEQuence	AUTO RETRigger AAUTo ARETrigger SINGle		
[SOURce<[1]2>:]BB:DVB:SETTing:CATalog?			Query only
[SOURce<[1]2>:]BB:DVB:SETTing:DELete	<file_name>		
[SOURce<[1]2>:]BB:DVB:SETTing:LOAD	<file_name>		
[SOURce<[1]2>:]BB:DVB:SETTing:STORE	<file_name>		
[SOURce<[1]2>:]BB:DVB:SRATe:VARiAtion	400 Hz ... 40 MHz	Hz (c/s)	
[SOURce<[1]2>:]BB:DVB:STANdard	DVBH DVBT		
[SOURce<[1]2>:]BB:DVB:STATe	ON OFF		
[SOURce<[1]2>:]BB:DVB:TRIGger:ARM:EXECute			No query
[SOURce<[1]2>:]BB:DVB:TRIGger:EXECute			No query
[SOURce<[1]2>:]BB:DVB:TRIGger[:EXTeRnal<[1]2>]:DELay	0 ...65 535 samples		
[SOURce<[1]2>:]BB:DVB:TRIGger[:EXTeRnal<[1]2>]:INHibit	0 ... (2 ²⁶ - 1) samples		
[SOURce<[1]2>:]BB:DVB:TRIGger:OBASeband:DELay	0 ...65 535 samples		
[SOURce<[1]2>:]BB:DVB:TRIGger:OBASeband:INHibit	0 ... (2 ²⁶ - 1) samples		
[SOURce<[1]2>:]BB:DVB:TRIGger:OUTPut<[1]...4>:DELay	0 ... (2 ²⁴ - 1) samples		
[SOURce<[1]2>:]BB:DVB:TRIGger:OUTPut:DELay:FIXed	ON OFF		
[SOURce<[1]2>:]BB:DVB:TRIGger:OUTPut<[1]...4>:DELay:MAXimum?			Query only
[SOURce<[1]2>:]BB:DVB:TRIGger:OUTPut<[1]...4>:DELay:MINimum?			Query only
[SOURce<[1]2>:]BB:DVB:TRIGger:OUTPut<[1]...4>:MODE	REStAr SFRAme FRAME PULSe PATTern RATio		
[SOURce<[1]2>:]BB:DVB:TRIGger:OUTPut<[1]...4>:OFFTime	0 ... (2 ²⁴ - 1) samples		
[SOURce<[1]2>:]BB:DVB:TRIGger:OUTPut<[1]...4>:ONTime	0 ... (2 ²⁴ - 1) samples		
[SOURce<[1]2>:]BB:DVB:TRIGger:OUTPut<[1]...4>:PATTern	#B0,1 ... #B111...1,32		
[SOURce<[1]2>:]BB:DVB:TRIGger:OUTPut<[1]...4>:PULSe:DIVider	2...1024		
[SOURce<[1]2>:]BB:DVB:TRIGger:OUTPut<[1]...4>:PULSe:FREQuency			Query only
[SOURce<[1]2>:]BB:DVB:TRIGger:RMODE			Query only
[SOURce<[1]2>:]BB:DVB:TRIGger:SLENgth	0 ... (2 ³² - 1) samples		
[SOURce<[1]2>:]BB:DVB:TRIGger:SLUNit	FRAME SEQUence		

Command	Parameter	Default Unit	Comments
[SOURce<[1] 2>:]BB:DVB:TRIGger:SOURce	EXTernal INTernal BEXTernal OBASeband		
[SOURce<[1] 2>:]BB:DVB:WAVeform:CREate			No query

[SOURce<[1]|2>:]BB:DVB:CLIPping:LEVel 1 ... 100 PCT

The command sets the limit for level clipping. This value indicates at what point the signal is clipped. It is specified as a percentage, relative to the highest level. 100% indicates that clipping does not take place.

Example: "BB:DVB:CLIP:LEV 80"
'sets the limit for level clipping to 80% of the maximum level.

"BB:DVB:CLIP:STAT ON"
'activates level clipping.

*RST value	Resolution	SCPI
100 PCT	1	Device-specific

[SOURce<[1]|2>:]BB:DVB:CLIPping:MODE VECTor | SCALar

The command sets the method for level clipping..

Parameters: **VECTor** The reference level is the amplitude | i+jq |.

SCALar The reference level is the absolute maximum of the I and Q values.

Example: "BB:DVB:CLIP:MODE VECT"
'sets the amplitude as reference level.

*RST value	Resolution	SCPI
VECTor	-	Device-specific

[SOURce<[1]|2>:]BB:DVB:CLIPping:STATE ON | OFF

The command activates level clipping. The value is defined with the command :BB:DVB:CLIPping:LEVel, the mode of calculation with the command :BB:DVB:CLIPping:MODE.

Example: "BB:DVB:CLIP:STAT ON"
'activates level clipping.

*RST value	Resolution	SCPI
OFF		Device-specific

[SOURCE<[1]2>:]BB:DVB:CLOCK:MODE SAMP | MSAMP

Note:

This command is available for R&S SMx and R&S AMU instruments only.

The command enters the type of externally supplied clock (BB:DVB:CLOCK:SOURCE EXTERNAL). When MSAMP is used, a multiple of the sample clock is supplied via the CLOCK connector and the sample clock is derived internally from this. The multiplier is entered with the command :BB:DVB:CLOCK:MULTIPLIER.

For two-path instruments, the only numerical suffix allowed for SOURCE is 1, since the external clock source is permanently allocated to path A.

Example: "BB:DVB:CLOCK:MODE MSAMP"
'sets the type of externally supplied clock.

*RST value	Resolution	SCPI
SAMP	-	Device-specific

[SOURCE<[1]2>:]BB:DVB:CLOCK:MULTIPLIER 1 ... 64

Note:

This command is available for R&S SMx and R&S AMU instruments only.

The command specifies the multiplier for clock type **Multiple Sample** (:BB:DVB:CLOCK:MODE MSAMP) in the case of an external clock source.

For two-path instruments, the only numerical suffix allowed for SOURCE is 1, since the external clock source is permanently allocated to path A.

Example: "BB:DVB:CLOCK:SOURCE EXT"
'selects the external clock source. The clock is supplied via the CLOCK connector.

"BB:DVB:CLOCK:MODE MSAMP"
'selects clock type **Multiple Sample**, i.e. the supplied clock has a rate which is a multiple of the sample rate.

"BB:DVB:CLOCK:MULT 12"
'the multiplier for the external clock rate is 12.

*RST value	Resolution	SCPI
4	1	Device-specific

[SOURce<[1]|2>:]BB:DVB:CLOCK:SOURce INTernal | EXTernal | AINTernal

Note:

This command is available for R&S SMx and R&S AMU instruments only.

The command selects the clock source.

For two-path instruments, selecting EXTernal is only possible for path A, since the external clock source is permanently allocated to path A; selecting AINTernal is only possible for path B.

Parameters:

INTernal The internal clock reference is used.

EXTernal The external clock reference is supplied to the CLOCK connector. Commands :BB:DVB:CLOCK:MODE and :MULTiplier are used to enter the type of the external clock.

Example:

"BB:DVB:CLOC:SOUR EXT"
'selects the external clock source. The clock is supplied via the CLOCK connector.

"BB:DVB:CLOC:MODE MSAM"
'selects clock type **Multiple Sample**, i.e. the supplied clock has a rate which is a multiple of the sample rate.

"BB:DVB:CLOC:MULT 12"
'the multiplier for the external clock rate is 12.

*RST value	Resolution	SCPI
INTernal	-	Device-specific

[SOURce<[1]|2>:]BB:DVB:DVBH | DVBT:DRATe ?

The command queries the data rate. The command is a query command and therefore does not have an *RST value.

Example:

"BB:DVB:DVBH:DRAT?"
'queries the data rate.

*RST value	Resolution	SCPI
-	-	Device-specific

[SOURce<[1]|2>:]BB:DVB:DVBH | DVBT:DURation ?

The command queries the signal duration. The command is a query command and therefore does not have an *RST value.

Example:

"BB:DVB:DVBH:DUR?"
'queries the signal duration.

*RST value	Resolution	SCPI
-	-	Device-specific

[SOURce<[1]|2>:]BB:DVB:DVBH | DVBT:SAMPlE:LENGth ?

The command queries the number of the transmitted samples. The command is a query command and therefore does not have an *RST value.

Example: "BB:DVB:DVBH:SAMP:LENG?"
'queries the number of the transmitted samples.

*RST value	Resolution	SCPI
-		Device-specific

[SOURce<[1]|2>:]BB:DVB:DVBH | DVBT:SAMPlE:RATE ?

The command queries the sample rate. The command is a query command and therefore does not have an *RST value.

Example: "BB:DVB:DVBH:SAMP:RATE?"
'queries the sample rate.

*RST value	Resolution	SCPI
-		Device-specific

[SOURce<[1]|2>:]BB:DVB:DVBH | DVBT:SFRames 1 ... 100

The command sets the number of super-frames to be transmitted.

Example: "BB:DVB:DVBH:SFR 50"
'sets the number of the transmitted super-frames to 50.

*RST value	Resolution	SCPI
1		Device-specific

[SOURce<[1]|2>:]BB:DVB:FILT:ILENth 1...128**Note:**

This command is available for WinIQSIM2 only.

The command sets the impulse length (number of filter tabs).

Example: "BB:DVB:FILT:ILEN 10"
'sets the number of filter tabs to 10.

*RST value	Resolution	SCPI
10	1	Device-specific

[SOURCE<[1]]2>:BB:DVB:FILTer:ILENght:AUTO ON | OFF

Note:

This command is available for WinIQSIM2 only.

The command activates/deactivates the impulse length state. If activated, the most sensible parameter values are selected. The value depends on the coherence check.

"BB:DVB:FILT:ILEN:AUTO ON"

Example: 'the most sensible parameters are selected automatically.

*RST value	Resolution	SCPI
ON	-	Device-specific

[SOURCE<[1]]2>:BB:DVB:FILTer:OSAMpling 1...32

Note:

This command is available for WinIQSIM2 only.

The command sets the upsampling factor.

"BB:DVB:FILT:OSAM 32"

Example: 'sets the upsampling factor to 32.

*RST value	Resolution	SCPI
32	-	Device-specific

[SOURCE<[1]]2>:BB:DVB:FILTer:OSAMpling:AUTO ON | OFF

Note:

This command is available for WinIQSIM2 only.

The command activates/deactivates the upsampling factor state. If activated, the most sensible parameter values are selected. The value depends on the coherence check. If deactivated, the values can be changed manually.

"BB:DVB:FILT:OSAM:AUTO ON"

Example: 'the most sensible parameters are selected automatically.

*RST value	Resolution	SCPI
ON	-	Device-specific

[SOURCE<[1]]2>:BB:DVB:FILTer:PARAmeter:APCO25 0.05 ... 0.99

The command sets the roll-off factor for filter type APCO25.

"BB:DVB:FILT:PAR:APCO25 0.2"

Example: 'sets the roll-off factor to 0.2 for filter type APCO25.

*RST value	Resolution	SCPI
0.20	0.01	Device-specific

[SOURce<[1]]2>:]BB:DVB:FILTer:PARAmeter:COsine 0.05 ... 0.99

The command sets the roll-off factor for the Cosine filter type.

Example: "BB:DVB:FILT:PAR:COs 0.35"
'sets the roll-off factor to 0.35 for filter type Cosine.

*RST value	Resolution	SCPI
0.10	0.01	Device-specific

[SOURce<[1]]2>:]BB:DVB:FILTer:PARAmeter:COsine:COFS -1.0 ... 1.0

The command sets the "cut off frequency shift" value for the Cosine filter type.

Example: "BB:DVB:FILT:PAR:COs:COFS 0.35"
'sets the "cut of frequency shift" value to 0.35.

*RST value	Resolution	SCPI
-0.1		Device-specific

[SOURce<[1]]2>:]BB:DVB:FILTer:PARAmeter:GAUSS 0.15 ... 2.5

The command sets the B x T for the Gauss filter type.

Example: "BB:DVB:FILT:PAR:GAUS 0.5"
'sets B x T to 0.5 for the Gauss filter type.

*RST value	Resolution	SCPI
0.5	0.01	Device-specific

[SOURce<[1]]2>:]BB:DVB:FILTer:PARAmeter:LPASs 0.05 ... 2.0

The command sets the cut off frequency factor for the Lowpass filter type.

Example: "BB:DVB:FILT:PAR:LPAS 0.5"
'the cut of frequency factor is set to 0.5.

*RST value	Resolution	SCPI
0.5	0.01	Device-specific

[SOURce<[1]]2>:]BB:DVB:FILTer:PARAmeter:PGAuss 0.15 ... 2.5

The command sets the B x T for the Pure Gauss filter type.

Example: "BB:DVB:FILT:PAR:GAUS 0.5"
'sets B x T to 0.5 for the Pure Gauss filter type.

*RST value	Resolution	SCPI
0.5	0.01	Device-specific

[SOURCE<[1]>:]BB:DVB:FILTER:PARAMeter:RCOSine 0.05 ... 0.99

The command sets the roll-off factor for the Root Cosine filter type.

Example: "BB:DVB:FILT:PAR:RCOS 0.22"
'sets the roll-off factor to 0.22 for filter type Root Cosine.

*RST value	Resolution	SCPI
0.22	0.01	Device-specific

[SOURCE<[1]>:]BB:DVB:FILTER:PARAMeter:SPHase 0.15 ... 2.5

The command sets the B x T for the Split Phase filter type.

Example: "BB:DVB:FILT:PAR:SPH 0.5"
'sets B x T to 0.5 for the Split Phase filter type.

*RST value	Resolution	SCPI
2.00	0.01	Device-specific

[SOURCE<[1]>:]BB:DVB:FILTER:TYPE RCOSine | COSine | GAUSs | LGAuss | CONE | COF705 | COEqualizer | COFequalizer | C2K3x | APCO25 | SPHase | RECTangle | PGAuss | LPASs | DIRac | ENPShape | EWPSHape

The command selects the filter type. The filter types are described in Chapter 4, Section "[Baseband Filter - Custom Digital Mod](#)".

Example: "BB:DVB:FILT:TYPE RCOS"
'sets the filter type RCOSine.

*RST value	Resolution	SCPI
GAUSs	-	Device-specific

[SOURCE<[1]>:]BB:DVB:PRESet

The command produces a standardized default for the DVB-H standard. The settings correspond to the *RST values specified for the commands.

This command triggers an action and therefore has no *RST value and no query form.

Example: "BB:DVB:PRES"
'resets all the DVB-H settings to default values.

*RST value	Resolution	Dependencies	SCPI
-	-	All DVB-H settings are preset. An overview is provided by Table in Chapter 4, Section "General Settings for DVB-H Signals".	Device-specific

[SOURce<[1]2>:]BB:DVB:SEQuence AUTO | RETRigger | AAUTo | ARETrigger | SINGle

Note:

This command is available for R&S SMx and R&S AMU instruments only.

The command selects the trigger mode.

- Parameters:**
- AUTO** The modulation signal is generated continuously.
 - RETRigger** The modulation signal is generated continuously. A trigger event (internal or external) causes a restart.
 - AAUTo** The modulation signal is generated only when a trigger event occurs. After the trigger event the signal is generated continuously, signal generation is stopped with command `SOUR:BB:DVB:TRIG:ARM:EXEC` and started again when a trigger event occurs.
 - ARETrigger** The modulation signal is generated only when a trigger event occurs. The device automatically toggles to RETRIG mode. Every subsequent trigger event causes a restart. Signal generation is stopped with command `SOUR:BB:DVB:TRIG:ARM:EXEC` and started again when a trigger event occurs.
 - SINGle** The modulation signal is generated only when a trigger event occurs. After the trigger event, the signal is generated once to the set sequence length (`SOUR:BB:DVB:TRIG:SLEN`). Every subsequent trigger event causes a restart.

Example: `"BB:DVB:SEQ AAUT"`
 'sets the **Armed_auto** trigger mode; the device waits for the first trigger (e.g. with `*TRG`) and then generates the signal continuously.

*RST value	Resolution	SCPI
AUTO	-	Device-specific

[SOURCE<[1]|2>:]BB:DVB:SETTING:CATalog?

This command reads out the files with DVB-H settings in the default directory. The default directory is set using command `MMEM:CDIRECTORY`. A path can also be specified, in which case the files in the specified directory are read. Only files with the file extension ***.DVB** will be listed.

The command is a query command and therefore has no *RST value.

Example:
`"MMEM:CDIR 'D:\user\DVB' "`
 'sets the default directory to D:\user\DVB.
`"BB:DVB:SETT:CAT?"`
 'reads out all the files with DVB-H settings in the default directory.
 Response: `"'DVB_1' , 'DVB_2' "`
 'the files 'DVB_1' and 'DVB_2' are available.

*RST value	Resolution	SCPI
-	-	Device-specific

[SOURCE<[1]|2>:]BB:DVB:SETTING:DELeTe <file_name>

This command deletes the selected file with DVB-H settings. The directory is set using command `MMEM:CDIRECTORY`. A path can also be specified, in which case the files in the specified directory are read. The file extension may be omitted. Only files with the file extension ***.DVB** will be deleted.

This command triggers an event and therefore has no *RST value and no query form.

Example:
`"BB:DVB:SETT:DEL 'D:\user\DVB' "`
 'deletes the specified file with DVB-H settings.

*RST value	Resolution	SCPI
-	-	Device-specific

[SOURCE<[1]|2>:]BB:DVB:SETTING:LOAD <file_name>

This command loads the selected file with DVB-H settings. The directory is set using command `MMEM:CDIRECTORY`. A path can also be specified, in which case the files in the specified directory are read. The file extension may be omitted. Only files with the file extension ***.DVB** will be loaded.

This command triggers an event and therefore has no *RST value and no query form.

Example:
`"BB:DVB:SETT:LOAD 'DVB_1' "`
 'loads file 'DVB_1'.

*RST value	Resolution	SCPI
-	-	Device-specific

[SOURCE<[1]>:]BB:DVB:SETTING:STORE <file_name>

This command stores the current DVB-H settings into the selected file. The directory is set using command `MMEM:CDIRECTORY`. A path can also be specified, in which case the files in the specified directory are read. Only the file name has to be entered. DVB-H settings are stored as files with the specific file extensions `*.DVB`.

This command triggers an event and therefore has no `*RST` value and no query form.

Example: `"BB:DVB:SETT:STOR 'DVB_1' "`
'stores the current DVB-H settings into file 'DVB_1'.

*RST value	Resolution	SCPI
-	-	Device-specific

[SOURCE<[1]>:]BB:DVB:SRATE:VARIATION 400 Hz ... 40 MHz

The command enters the output sample rate.

A variation of this parameter only affects the ARB clock rate, all other signal parameters remain unchanged. If the sampling rate in the frame configuration menu is changed, this parameter is reset to the chosen sampling rate.

Example: `"BB:DVB:SRAT:VAR 40 MHz "`
'sets the output sample rate to 40 MHz.

*RST value	Resolution	SCPI
2 MHz	0.001 Hz	Device-specific

[SOURCE<[1]>:]BB:DVB:STANDARD DVBT | DVBH

The command selects the DVB standard to be used.

Note:

In this release only DVB-H is available.

Example: `"BB:DVB:STAN DVBH "`
'selects the DVB-H standard to be used.

*RST value	Resolution	SCPI
DVBH	-	Device-specific

[SOURCE<[1]>:]BB:DVB:STATE ON | OFF

The command activates modulation in accordance with the DVB-H standard. Activating this standard deactivates all the other digital standards and digital modulation modes (in case of two-path instruments, this affects the same path).

Example: `"BB:DVB:STAT ON "`
'activates modulation in accordance with the DVB-H standard.

*RST value	Resolution	Dependencies	SCPI
OFF	-	BB:DVB:STAT ON deactivates the other standards and digital modulation.	Device-specific

[SOURce<[1]|2>:]BB:DVB:TRIGger:ARM:EXECute

Note:

This command is available for R&S SMx and R&S AMU instruments only.

The command stops signal generation for trigger modes **Armed Auto** and **Armed Retrigger**. A subsequent internal or external trigger event restart signal generation.

This command triggers an event and therefore has no *RST value and no query form.

Example: "BB:DVB:TRIG:ARM:EXEC"
'stops signal generation for trigger modes **Armed Auto** and **Armed Retrigger**.

*RST value	Resolution	SCPI
-	-	Device-specific

[SOURce<[1]|2>:]BB:DVB:TRIGger:EXECute

Note:

This command is available for R&S SMx and R&S AMU instruments only.

The command executes a trigger. The internal trigger source must be selected using the command SOUR:BB:DVB:TRIG:SOUR INT and a trigger mode other than **AUTO** must be selected using the command SOUR:BB:DVB:TRIG:SEQ.

This command triggers an event and therefore has no *RST value and no query form.

Example: "BB:DVB:TRIG:SOUR INT"
'sets internal triggering.
"BB:DVB:TRIG:SEQ RETR"
'sets Retrigger mode, i.e. every trigger event causes signal generation to restart.
"BB:DVB:TRIG:EXEC"
'executes a trigger.

*RST value	Resolution	SCPI
-		Device-specific

[SOURce<[1]|2>:]BB:DVB:TRIGger[:EXTernal<[1]|2>]:DELay 0 ... 65 535 samples

Note:

This command is available for R&S SMx and R&S AMU instruments only.

The command specifies the trigger delay (expressed as a number of samples) for external triggering. The numeric suffix to EXTernal distinguishes between the external trigger via the TRIGGER 1 (suffix 1) and TRIGGER 2 (suffix 2) connector.

Example: "BB:DVB:TRIG:SOUR EXT"
'sets an external trigger via the TRIGGER 1 connector.
"BB:DVB:TRIG:DEL 50"
'sets a delay of 50 symbols for the trigger.

*RST value	Resolution	SCPI
0 samples	1 sample	Device-specific

[SOURCE<[1]|2>:]BB:DVB:TRIGGER[:EXTERNAL<[1]|2>]:INHIBIT 0 ...67 108 863 samples

Note:

This command is available for R&S SMx and R&S AMU instruments only.

The command specifies the number of samples by which a restart is to be inhibited following a trigger event. This command applies only in the case of external triggering. The numeric suffix to EXTERNAL distinguishes between the external trigger via the TRIGGER 1 (suffix 1) and TRIGGER 2 (suffix 2) connector.

Example:

```
"BB:DVB:TRIG:SOUR EXT1"
```

'selects an external trigger via the TRIGGER 1 connector.

```
"BB:DVB:TRIG:INH 200"
```

'sets a restart inhibit for 200 samples following a trigger event.

*RST value	Resolution	SCPI
0 samples	1 sample	Device-specific

SOURCE<[1]|2>:]BB:DVB:TRIGGER:OBASband:DELAY 0 ... 65 535 samples

Note:

This command is available for R&S SMx and R&S AMU two-path instruments only.

The command specifies the trigger delay (expressed as a number of samples) for triggering by the trigger signal from the second path.

Example:

```
"BB:DVB:TRIG:SOUR OBAS"
```

'sets for path A the internal trigger executed by the trigger signal from the second path (path B).

```
"BB:DVB:TRIG:OBAS:DEL 50"
```

'sets a delay of 50 symbols for the trigger.

*RST value	Resolution	SCPI
0 samples	1 sample	Device-specific

SOURCE<[1]|2>:]BB:DVB:TRIGGER:OBASband:INHIBIT 0 ...67 108 863 samples

Note:

This command is available for R&S SMx and R&S AMU two-path instruments only.

The command specifies the number of samples by which a restart is to be inhibited following a trigger event. This command applies only for triggering by the second path.

Example:

```
"BB:DVB:TRIG:SOUR OBAS"
```

'sets for path A the internal trigger executed by the trigger signal from the second path (path B).

```
"BB:DVB:TRIG:INH 200"
```

'sets a restart inhibit for 200 samples following a trigger event.

*RST value	Resolution	SCPI
0 samples	1 sample	Device-specific

[SOURce<[1]|2>:]BB:DVB:TRIGger:OUTPut<[1]...4>:DELay 0 .. (2²⁴ - 1) samples

Note:

This command is available for R&S SMx and R&S AMU instruments only.

The command defines the delay between the signal on the marker outputs and the start of the signal, expressed in terms of samples. Command BB:DVB:TRIGger:OUTPut:DELay:FIXed can be used to restrict the range of values to the dynamic range, i.e. the range within which a delay of the marker signals can be set without restarting the marker and signal.

Example: "BB:DVB:TRIG:OUTP2:DEL 16000"
'sets a delay of 16000 samples for the signal on connector MARKER 2.

*RST value	Resolution	SCPI
0		Device-specific

[SOURce<[1]|2>:]BB:DVB:TRIGger:OUTPut:DELay:FIXed ON | OFF

Note:

This command is available for R&S SMx and R&S AMU instruments only.

The command restricts the marker delay setting range to the current range. In this range the delay can be set without restarting the marker and signal. If a delay is entered in setting ON but is outside this range, the maximum possible delay is set and an error message is generated.

The numeric suffix in OUTPut has no significance for this command, since the setting always affects every marker.

Example: "BB:DVB:TRIG:OUTP:DEL:FIX ON"
'restricts the marker signal delay setting range to the current range.

*RST value	Resolution	SCPI
OFF	-	Device-specific

[SOURce<[1]|2>:]BB:DVB:TRIGger:OUTPut<[1]...4>:DELay:MAXimum?

Note:

This command is available for R&S SMx and R&S AMU instruments only.

The command queries the maximum marker delay for setting :BB:DVB:TRIG:OUTP:DEL:FIX ON.

The command is a query only and therefore has no *RST value.

Example: "BB:DVB:TRIG:OUTP:DEL:FIX ON"
'restricts the marker signal delay setting range to the dynamic range.

"BB:DVB:TRIG:OUTP:DEL:MAX?"
'queries the maximum of the dynamic range.

Response: "20000"
'the maximum for the marker delay setting is 20000 samples.

*RST value	Resolution	SCPI
-	-	Device-specific

[SOURce<[1]|2>:]BB:DVB:TRIGger:OUTPut<[1]...4>:DELay:MINimum?

Note:

This command is available for R&S SMx and R&S AMU instruments only.

The command queries the minimum marker delay for setting
:BB:DVB:TRIGger:OUTPut:DELay:FIXed ON.

The command is a query only and therefore has no *RST value.

Example:

"BB:DVB:TRIG:OUTP:DEL:FIX ON"
'restricts the marker signal delay setting range to the dynamic range.

"BB:DVB:TRIG:OUTP:DEL:MIN?"
'queries the minimum of the dynamic range.

Response: "0"
'the minimum for the marker delay setting is 0 symbols.

*RST value	Resolution	SCPI
-	-	Device-specific

[SOURce<[1]|2>:]BB:DVB:TRIGger:OUTPut<[1]...4>:MODE REStart | SFRAme | FRAME | PULSe | PATTErn | RATio

The command defines the signal for the selected marker output.

- Parameters:**
- REStart** A marker signal is generated at the start of every sequence length loop.
 - SFRAme** A marker signal is generated at the start of every super-frame period.
 - FRAME** A marker signal is generated at the start of every frame.
 - PULSe** A marker pulse is generated continuously according to the frequency and frequency divider.
 - PATTErn** A marker signal is generated due to a bit pattern given by the user. Each bit represents a sample and can be switched on or off.
 - RATio** A regular marker signal that is defined by an ON/OFF ratio is generated. A period lasts one ON and OFF cycle. The ON time and OFF time are each expressed as a number of samples and are set in an input field which opens when On/Off Ratio is selected.

Example: "BB:DVB:TRIG:OUTP2:MODE FRAME"
'selects the frame marker signal on output MARKER 2.

*RST value	Resolution	SCPI
REStart	-	Device-specific

[SOURce<[1]|2>:]BB:DVB:TRIGger:OUTPut<[1]...4>:OFFTime 1 ... 2²⁴ - 1 (16 777 215) samples

The command sets the number of samples in a period (ON time + OFF time) during which the marker signal in setting `SOURce:BB:DVB:TRIGger:OUTPut:MODE RATio` on the marker outputs is OFF.

Example: `"BB:DVB:TRIG:OUTP2:OFFT 2000"`
 'sets an OFF time of 2000 samples for marker signal 2.

*RST value	Resolution	SCPI
1 sample	1	Device-specific

[SOURce<[1]|2>:]BB:DVB:TRIGger:OUTPut<[1]...4>:ONTime 1 ... 2²⁴ - 1 (16 777 215) samples

The command sets the number of samples in a period (ON time + OFF time) during which the marker signal in setting `SOURce:BB:DVB:TRIGger:OUTPut:MODE RATio` on the marker outputs is ON.

Example: `"BB:DVB:TRIG:OUTP2:ONT 2000"`
 'sets an ON time of 2000 samples for marker 2.

*RST value	Resolution	SCPI
1 sample	1	Device-specific

[SOURce<[1]|2>:]BB:DVB:TRIGger:OUTPut<[1]...4>:PATTern #B0,1...B111...1.32

The command defines the bit pattern used to generate the marker signal.

Example: `"BB:DVB:TRIG:OUTP2:PATT #H39FE0000,32"`
 'sets the bit pattern.
`"BB:DVB:TRIG:OUTP2:MODE PATT"`
 'activates the marker signal according to a bit pattern on output MARKER 2.

*RST value	Resolution	SCPI
0		Device-specific

[SOURce<[1]|2>:]BB:DVB:TRIGger:OUTPut<[1]...4>:PULSe:DIVider -2...1024

The command sets the divider for the pulsed marker signal in the setting `SOURce:BB:DVB:TRIGger:OUTPut:MODE PULSe`. The pulse frequency is derived by dividing the symbol rate by the divider.

Example: `"BB:DVB:TRIG:OUTP2:PULS:DIV 2"`
 'sets the divider for the marker signal on output MARKER 2 to the value 2.
`"BB:DVB:TRIG:OUTP2:FREQ?"`
 'queries the resulting pulse frequency of the marker signal.
 Response: `"66 000"`
 'the resulting pulse frequency is 66 kHz.

*RST value	Resolution	SCPI
0	1	Device-specific

[SOURce<[1]|2>:]BB:DVB:TRIGger:OUTPut<[1]...4>:PULSe:FREQUency ?

The command queries the pulse frequency of the pulsed marker signal in the setting :BB:DVB:TRIGger:OUTPut:MODE PULSe. The pulse frequency is derived by dividing the symbol rate by the divider. The divider is defined with command :BB:DVB:TRIG:OUTP:PULS:DIV.

Example: "BB:DVB:TRIG:OUTP2:PULS:DIV 2"
'sets the divider for the marker signal on output MARKER 2 to the value 2.

"BB:DVB:TRIG:OUTP2:MODE PULS"
'enables the pulsed marker signal.

"BB:DVB:TRIG:OUTP2:FREQ?"
'queries the resulting pulse frequency of the marker signal.

Response: "66 000"
'the resulting pulse frequency is 66 kHz.

*RST value	Resolution	SCPI
-	-	Device-specific

[SOURce<[1]|2>:]BB:DVB:TRIGger:RMODE

Note:
This command is available for R&S SMx and R&S AMU instruments only.

The command queries the current status of signal generation for all trigger modes with DVB-H modulation on.

The command is a query command and therefore has no *RST value.

Parameter: **RUN** the signal is generated. A trigger event occurred in the triggered mode.

STOP the signal is not generated. A trigger event did not occur in the triggered modes, or signal generation was stopped by the command :BB:DVB:TRIG:ARM:EXECute (armed trigger modes only).

Example: BB:DVB:TRIG:SOUR EXT"
'sets external triggering via the TRIGGER 1 connector.

BB:DVB:TRIG:MODE ARET"
'selects the Armed_Retrigger mode

BB:DVB:TRIG:RMODE?"
'queries the current status of signal generation.

Response: "RUN"
'the signal is generated, an external trigger was executed.

*RST value	Resolution	SCPI
-	-	Device-specific

[SOURce<[1]|2>:]BB:DVB:TRIGger:SLENgth 1 ... 2³²-1 (4 294 967 295) samples

Note:

This command is available for R&S SMx and R&S AMU instruments only.

The command defines the length of the signal sequence to be output in the **Single** trigger mode (SOUR:BB:DVB:SEQ SING). The unit is defined with command SOUR:BB:DVB:TRIG:SLUNit. It is then possible to output deliberately just part of the frame, an exact sequence of the frame, or a defined number of repetitions of the frame.

Example:

BB:DVB:SEQ SING "

'sets trigger mode Single.

BB:DVB:TRIG:SLUN FRAM "

'sets unit frames for the entry of sequence length.

BB:DVB:TRIG:SLEN 200 "

'sets a sequence length of 200 frames. The current frame will be output 200 times after the next trigger event.

*RST value	Resolution	SCPI
1 sequence length	-	Device-specific

[SOURce<[1]|2>:]BB:DVB:TRIGger:SLUNit FRAME | SEQUENCE

Note:

This command is available for R&S SMx and R&S AMU instruments only.

The command defines the unit for the entry of the length of the signal sequence (SOUR:BB:DVB:TRIG:SLEN) to be output in the **Single** trigger mode (SOUR:BB:DVB:SEQ SING).

Example:

BB:DVB:SEQ SING "

'sets trigger mode Single.

BB:DVB:TRIG:SLUN FRAM "

'sets unit frames for the entry of sequence length.

BB:DVB:TRIG:SLEN 2 "

'sets a sequence length of 2 frames. The current frame will be output twice after the next trigger event.

*RST value	Resolution	SCPI
SEQUence	-	Device-specific

[SOURce<[1]|2>:]BB:DVB:TRIGger:SOURce INTernal | EXTernal | BEXTernal | OBASeband

Note:

This command is available for R&S SMx and R&S AMU instruments only.

The command selects the trigger source.

Parameter:	INTernal	Triggering is executed by means of the Trigger command :BB:DVB:TRIGger:EXECute or *TRG in the case of remote control and by means of Execute Trigger in the case of manual operation.
	EXTernal	Triggering is executed by means of the signal on the TRIGGER 1 connector.
	BEXTernal	Triggering is executed by means of the signal on the TRIGGER 2 connector.
	OBASeband	Triggering is executed by means of the trigger signal from the second path (two-path instruments only).

Example: "BB:DVB:TRIG:SOUR EXT"
'executes triggering by means of the signal on the TRIGGER 1 connector.

*RST value	Resolution	SCPI
INTernal	-	Device-specific

[SOURce<[1]|2>:]BB:DVB:WAVEform:CREate <file_name>

This command creates a waveform using the current settings of the **DVB-H** menu. The file name is entered with the command. The file is stored with the predefined file extension *.**wv**. The file name and the directory it is stored in are user-definable.

This command triggers an event and therefore has no *RST value and no query form.

Example: "MMEM:CDIR 'D:\user\waveform'
'sets the default directory to D:\user\waveform.
"BB:DVB:WAV:CRE 'DVB_1'
'creates the waveform file DVB.wv in the default directory.

*RST value	Resolution	SCPI
-	-	device-specific

System Configuration

This subsystem contains commands regarding the system configuration of the DVB-H standard.

Command	Parameter	Default Unit	Comments
[SOURce<[1] 2>:]BB:DVB:DVBH DVBT:HMODE	NHlerarchical HIERarchical		
[SOURce<[1] 2>:]BB:DVB:DVBH DVBT:HP LP:DATA	PAC0 PAC1 PN15 PN23 DLISt		
[SOURce<[1] 2>:]BB:DVB:DVBH DVBT:HP LP:DATA:DSElection	<data list>		
[SOURce<[1] 2>:]BB:DVB:DVBH DVBT:HP LP:ICODer:RATE	CR1D2 CR2D3 CR3D4 CR5D6 CR7D8		
[SOURce<[1] 2>:]BB:DVB:DVBH DVBT:HP LP:ICODer[:STATe]	ON OFF		
[SOURce<[1] 2>:]BB:DVB:DVBH DVBT:HP LP:OCODer[:STATe]	ON OFF		
[SOURce<[1] 2>:]BB:DVB:DVBH DVBT:HP LP:OINTerleaver:STATe	ON OFF		
[SOURce<[1] 2>:]BB:DVB:DVBH DVBT:HP LP:PNSCrambler:STATe	ON OFF		
[SOURce<[1] 2>:]BB:DVB:DVBH DVBT:IINTerleaver:BIT:STATE	ON OFF		
[SOURce<[1] 2>:]BB:DVB:DVBH DVBT:IINTerleaver:SYMBol:MODE	NATive IDEPth		
[SOURce<[1] 2>:]BB:DVB:DVBH DVBT:IINTerleaver:SYMBol[:STATe]	ON OFF		
[SOURce<[1] 2>:]BB:DVB:DVBH DVBT:IINTerleaver:SYMBol:TMODE	T2K T4K T8K		
[SOURce<[1] 2>:]BB:DVBH DVBT:OFDM:ALPHa	1 2 3		
[SOURce<[1] 2>:]BB:DVBH DVBT:OFDM:BWIDth	5 6 7 8	MHz	
[SOURce<[1] 2>:]BB:DVBH DVBT:OFDM:GINTerval	G11D4 G11D8 G11D16 G11D32		
[SOURce<[1] 2>:]BB:DVBH DVBT:OFDM:MODulation	QPSK QAM16 QAM64		

[SOURce<[1]|2>:]BB:DVBH | DVBT:HMODE NHlerarchical | HIERarchical

The command selects either to use one path or both path with different prioritization.

Note:

In this release only the non-hierarchical mode is available.

Example:

"BB:DVB:DVBH:HMOD NHI"

'selects the non-hierarchical mode to be used. Only path one is used, that is, no prioritization is necessary.

*RST value	Resolution	SCPI
NHIERarchical	-	Device-specific

[SOURce<[1]|2>:]BB:DVBH | DVBT:HP | LP:DATA PAC0 | PAC1 | PN15 | PN23 | DLIS

The command selects the data source to be used.

- Parameter:**
- ZERO** Internal 0 is used.
 - ONE** Internal 1 is used.
 - PN15/23** PRBS data as per CCITT with period lengths between 29-1 and 223-1 is generated internally.
 - DLIS** Internal data from a TS file is used.

Example: "BB:DVB:DVBH:HP:DATA PN23"
'selects PN23 as data source.

*RST value	Resolution	SCPI
PN23	-	Device-specific

[SOURce<[1]|2>:]BB:DVBH | DVBT:HP | LP:DATA:DSElection <data list>

The command selects the TS file for the data source selection.

The lists are stored as files with the fixed file extensions ***.gts**, ***.ts**, or ***.trp** in a directory of the user's choice. The directory applicable to the following commands is defined with the command **MMEMory:CDIR**. To access the files in this directory, you only have to give the file name, without the path and the file extension.

Example: "BB:DVB:DVBH:HP:DATA DLIS"
'selects the data list as the data source.

"MMEM:CDIR 'D:\Lists\DVB\TestData'"
'selects the directory for the data lists.

"BB:DVB:DVBH:HP:DATA:DSEL 'dvh_1'"
'selects the file 'dvh_1' as the data source. This file must be in the directory D:\Lists\DVB\TestData and have the file extension *.gts, *.ts, or *.trp.

*RST value	Resolution	SCPI
-	-	Device-specific

[SOURce<[1]|2>:]BB:DVBH | DVBT:HP | LP:ICODer:RATE CR1D2 | CR2D3 | CR3D4 | CR5D6 | CR7D8

The command selects the code rate of the inner coder.

Example: "BB:DVB:DVBH:HP:ICOD:RATE CR1D2"
'sets the rate to CR1D2.

*RST value	Resolution	SCPI
CR1D2	-	Device-specific

[SOURCE<[1]>:]BB:DVBH | DVBT:HP | LP:ICODer[:STATe] ON | OFF

The command activates/deactivates the inner coder.

Example: "BB:DVB:DVBH:HP:ICOD ON"
'activates the inner coder.

*RST value	Resolution	SCPI
ON	-	Device-specific

[SOURCE<[1]>:]BB:DVBH | DVBT:HP | LP:OCODer[:STATe] ON | OFF

The command activates/deactivates the outer coder (RS).

Example: "BB:DVB:DVBH:HP:OCOD:STAT ON"
'activates the outer coder.

*RST value	Resolution	SCPI
ON	-	Device-specific

[SOURCE<[1]>:]BB:DVBH | DVBT:HP | LP:OINTerleaver[:STATe] ON | OFF

The command activates/deactivates the outer interleaver.

Example: "BB:DVB:DVBH:HP:OINT ON"
'activates the outer interleaver.

*RST value	Resolution	SCPI
ON	-	Device-specific

[SOURCE<[1]>:]BB:DVBH | DVBT:HP | LP:PNScrambler[:STATe] ON | OFF

The command activates/deactivates the PN scrambler.

Example: "BB:DVB:DVBH:HP:PNSC ON"
'activates the PN scrambling, that is, transforming the data packets of the incoming transport stream to a Pseudo Random Binary Sequence (PRBS).

*RST value	Resolution	SCPI
ON	-	Device-specific

[SOURCE<[1]>:]BB:DVBH | DVBT:IINTerleaver:BIT[:STATe] ON | OFF

The command activates/deactivates the inner bit interleaver.

Example: "BB:DVB:DVBH:IINT:BIT ON"
'activates the inner bit interleaver.

*RST value	Resolution	SCPI
ON	-	Device-specific

[SOURCE<[1]>:]BB:DVBH | DVBT:IINTERleaver:SYMBOL:MODE NATive | IDEPth

The command selects the inner interleaver mode.

Parameter: **NATive** The interleaver interleaves the bits over one OFDMA symbol.

IDEPth The interleaver interleaves the bits over two (4K transmission mode) or four (2K transmission mode) OFDMA symbols.

Example: "BB:DVB:DVBH:IINT:SYMB:MODE NAT"
'sets the inner interleaver mode to **Native**.

*RST value	Resolution	SCPI
NATive	-	Device-specific

[SOURCE<[1]>:]BB:DVBH | DVBT:IINTERleaver:SYMBOL[:STATE] ON | OFF

The command activates/deactivates the inner symbol interleaver.

Example: "BB:DVB:DVBH:IINT:SYMB ON"
'activates the inner symbol interleaver.

*RST value	Resolution	SCPI
ON	-	Device-specific

[SOURCE<[1]>:]BB:DVBH | DVBT:IINTERleaver:SYMBOL:TMODE T2K | T4K | T8K

The command selects the transmission mode.

Example: "BB:DVB:DVBH:IINT:SYMB:TMOD T2K"
'sets the transmission mode to T2K.

*RST value	Resolution	Dependencies	SCPI
T2K	-		Device-specific

[SOURCE<[1]>:]BB:DVBH | DVBT:OFDM:ALPHA 1 | 2 | 4

The command selects the α value. This value is used to shape the constellation of the modulation. For DVB-H, this value is always 1.

Example: "BB:DVB:DVBH:OFDM:ALPH 1"
'sets the α value to 1.

*RST value	Resolution	SCPI
1	-	Device-specific

[SOURCE<[1]>:]BB:DVBH | DVBT:OFDM:BWIDth 5 | 6 | 7 | 8

The command selects the system bandwidth.

Example: "BB:DVB:DVBH:OFDM:BWID 8"
'sets the OFDM bandwidth to 8 MHz.

*RST value	Resolution	SCPI
8 MHz	-	Device-specific

[SOURCE<[1]>:]BB:DVBH | DVBT:OFDM:GINTerval GI1D4 | GI1D8 | GI1D16 | GI1D32

The command selects the OFDM/RF guard interval.

Example: "BB:DVB:DVBH:OFDM:GINT GI1D8"
'sets the OFDM guard interval to 1/8 of the symbol period.

*RST value	Resolution	SCPI
GI1D8	-	Device-specific

[SOURCE<[1]>:]BB:DVBH | DVBT:OFDM:MODulation QPSK | QAM16 | QAM64

The command selects the constellation for the OFDM modulation.

Example: "BB:DVB:DVBH:OFDM:MOD QAM16"
'selects 16-QAM as the constellation for the OFDM modulation.

*RST value	Resolution	SCPI
QPSK	-	Device-specific

TPS Settings

This subsystem contains commands regarding the TPS parameter bits.

Command	Parameter	Default Unit	Comments
[SOURCE<[1]>:]BB:DVB:DVBH DVBT:TPS:ID:PATtern	0000...FFFF		
[SOURCE<[1]>:]BB:DVB:DVBH DVBT:TPS:ID:STATe	ON Off		
[SOURCE<[1]>:]BB:DVB:DVBH DVBT:TPS:MFEC:STATe	ON OFF		
[SOURCE<[1]>:]BB:DVB:DVBH DVBT:TPS:TSLicing:STATe	ON OFF		

[SOURCE<[1]>:]BB:DVBH | DVBT:TPS:ID:PATtern 0000...FFFF

The command sets the pattern for cell identification.

Example: "BB:DVB:DVBH:TPS:ID:PATT 0000"
'sets the cell identification to 0000.

*RST value	Resolution	SCPI
0000	-	Device-specific

[SOURCE<[1]>:]BB:DVBH | DVBT:TPS:ID:STATe ON | OFF

The command activates/deactivates the TPS cell identification.

Example: "BB:DVB:DVBH:TPS:ID:STAT ON"
'activates the TPS cell identification.

*RST value	Resolution	SCPI
ON	-	Device-specific

[SOURCE<[1]>:]BB:DVBH | DVBT:TPS:MFEC[:STATe] ON | OFF

The command activates/deactivates the multiprotocol encapsulation forward error correction bit.

Example: "BB:DVB:DVBH:TPS:MFEC:STAT ON"
'activates the multiprotocol encapsulation forward error correction bit.

*RST value	Resolution	SCPI
ON	-	Device-specific

[SOURCE<[1]>:]BB:DVBH | DVBT:TPS:TSLicing[:STATe] ON | OFF

The command activates/deactivates the time-slicing bit.

Example: "BB:DVB:DVBH:TPS:TSL ON"
'activates the time-slicing.

*RST value	Resolution	SCPI
ON	-	Device-specific

Alphabetical List of Commands

[SOURCE<1>2>]:BB:DVB:CLIPping:LEVel.....	42
[SOURCE<1>2>]:BB:DVB:CLIPping:MODE.....	42
[SOURCE<1>2>]:BB:DVB:CLIPping:STATe.....	42
[SOURCE<1>2>]:BB:DVB:CLOCK:MODE.....	44
[SOURCE<1>2>]:BB:DVB:CLOCK:MULTIplier.....	44
[SOURCE<1>2>]:BB:DVB:CLOCK:SOURce.....	45
[SOURCE<1>2>]:BB:DVB:DVbH DVBT:DRATe.....	45
[SOURCE<1>2>]:BB:DVB:DVbH DVBT:HMODe.....	66
[SOURCE<1>2>]:BB:DVB:DVbH DVBT:HP LP:OCODer:STATe].....	68
[SOURCE<1>2>]:BB:DVB:DVbH DVBT:HP LP:DATA.....	67
[SOURCE<1>2>]:BB:DVB:DVbH DVBT:HP LP:DATA:DSELectIon.....	67
[SOURCE<1>2>]:BB:DVB:DVbH DVBT:HP LP:ICODer[:STATe].....	68
[SOURCE<1>2>]:BB:DVB:DVbH DVBT:HP LP:ICODer:RATE.....	67
[SOURCE<1>2>]:BB:DVB:DVbH DVBT:HP LP:OINTerleaver[:STATe].....	68
[SOURCE<1>2>]:BB:DVB:DVbH DVBT:HP LP:PNScrambler[:STATe].....	68
[SOURCE<1>2>]:BB:DVB:DVbH DVBT:IIINTerleaver:BIT[:STATe].....	69
[SOURCE<1>2>]:BB:DVB:DVbH DVBT:IIINTerleaver:SYMBOL[:STATe].....	69
[SOURCE<1>2>]:BB:DVB:DVbH DVBT:IIINTerleaver:SYMBOL:MODE.....	69
[SOURCE<1>2>]:BB:DVB:DVbH DVBT:IIINTerleaver:SYMBOL:TMODe.....	69
[SOURCE<1>2>]:BB:DVB:DVbH DVBT:OFDM:ALPha.....	70
[SOURCE<1>2>]:BB:DVB:DVbH DVBT:OFDM:BWIDTh.....	71
[SOURCE<1>2>]:BB:DVB:DVbH DVBT:OFDM:GINTeval.....	71
[SOURCE<1>2>]:BB:DVB:DVbH DVBT:OFDM:MODulation.....	71
[SOURCE<1>2>]:BB:DVB:DVbH DVBT:SAMPle:LENGTh.....	46
[SOURCE<1>2>]:BB:DVB:DVbH DVBT:SAMPle:RATE.....	46
[SOURCE<1>2>]:BB:DVB:DVbH DVBT:SFRames.....	46
[SOURCE<1>2>]:BB:DVB:DVbH DVBT:TPS:ID:PATTeRn.....	72
[SOURCE<1>2>]:BB:DVB:DVbH DVBT:TPS:ID:STATe.....	72
[SOURCE<1>2>]:BB:DVB:DVbH DVBT:TPS:MFEC[:STATe].....	72
[SOURCE<1>2>]:BB:DVB:DVbH DVBT:TPS:TSLicing8:STATe].....	72
[SOURCE<1>2>]:BB:DVB:DVbH DVBT:DURation.....	45
[SOURCE<1>2>]:BB:DVB:FiLTeR:ILENGTh.....	46
[SOURCE<1>2>]:BB:DVB:FiLTeR:ILENGTh:AUTO.....	48
[SOURCE<1>2>]:BB:DVB:FiLTeR:OSAMpling.....	48
[SOURCE<1>2>]:BB:DVB:FiLTeR:OSAMpling:AUTO.....	48
[SOURCE<1>2>]:BB:DVB:FiLTeR:PARAmeter:APCO25.....	48
[SOURCE<1>2>]:BB:DVB:FiLTeR:PARAmeter:COsIne.....	50
[SOURCE<1>2>]:BB:DVB:FiLTeR:PARAmeter:COsIne:COFS.....	50
[SOURCE<1>2>]:BB:DVB:FiLTeR:PARAmeter:GAUSs.....	50
[SOURCE<1>2>]:BB:DVB:FiLTeR:PARAmeter:LPASs.....	50
[SOURCE<1>2>]:BB:DVB:FiLTeR:PARAmeter:PGAuss.....	50
[SOURCE<1>2>]:BB:DVB:FiLTeR:PARAmeter:RCOSIne.....	51
[SOURCE<1>2>]:BB:DVB:FiLTeR:PARAmeter:SPHase.....	51
[SOURCE<1>2>]:BB:DVB:FiLTeR:TYPE.....	51
[SOURCE<1>2>]:BB:DVB:PRESet.....	51
[SOURCE<1>2>]:BB:DVB:SEQuence.....	53
[SOURCE<1>2>]:BB:DVB:SETTing:CATalog?.....	54
[SOURCE<1>2>]:BB:DVB:SETTing:DELete.....	54
[SOURCE<1>2>]:BB:DVB:SETTing:LOAD.....	54
[SOURCE<1>2>]:BB:DVB:SETTing:STORE.....	55
[SOURCE<1>2>]:BB:DVB:SRATe:VARiAtion.....	55
[SOURCE<1>2>]:BB:DVB:STANdard.....	55
[SOURCE<1>2>]:BB:DVB:STATe.....	55
[SOURCE<1>2>]:BB:DVB:TRIGger[:EXTeRnal<1>2>]:DELay.....	56
[SOURCE<1>2>]:BB:DVB:TRIGger[:EXTeRnal<1>2>]:INHibit.....	57
[SOURCE<1>2>]:BB:DVB:TRIGger:ARM:EXECute.....	56
[SOURCE<1>2>]:BB:DVB:TRIGger:EXECute.....	56
[SOURCE<1>2>]:BB:DVB:TRIGger:OBASband:INHibit.....	58
[SOURCE<1>2>]:BB:DVB:TRIGger:OBASband:DELay.....	57
[SOURCE<1>2>]:BB:DVB:TRIGger:OUTPut<1>...4>:DELay.....	58
[SOURCE<1>2>]:BB:DVB:TRIGger:OUTPut<1>...4>:DELay:FiXed.....	58
[SOURCE<1>2>]:BB:DVB:TRIGger:OUTPut<1>...4>:DELay:MAXimum?.....	59
[SOURCE<1>2>]:BB:DVB:TRIGger:OUTPut<1>...4>:DELay:MINimum?.....	59
[SOURCE<1>2>]:BB:DVB:TRIGger:OUTPut<1>...4>:MODE.....	60
[SOURCE<1>2>]:BB:DVB:TRIGger:OUTPut<1>...4>:OFFTime.....	60
[SOURCE<1>2>]:BB:DVB:TRIGger:OUTPut<1>...4>:ONTTime.....	60
[SOURCE<1>2>]:BB:DVB:TRIGger:OUTPut<1>...4>:PATTeRn.....	61

[SOURce<[1]2>:]BB:DVB:TRIGger:OUTPut<[1]...4>:PULSe:DIVider	61
[SOURce<[1]2>:]BB:DVB:TRIGger:OUTPut<[1]...4>:PULSe:FREQuency	61
[SOURce<[1]2>:]BB:DVB:TRIGger:RMODE?	62
[SOURce<[1]2>:]BB:DVB:TRIGger:SLENgth	63
[SOURce<[1]2>:]BB:DVB:TRIGger:SLUNit	63
[SOURce<[1]2>:]BB:DVB:TRIGger:SOURce	64
[SOURce<[1]2>:]BB:DVB:WAVeform:CREate	64

Index

A

Activate DVB-H Standard	10
Alpha - DVB-H	16
Arm Trigger - DVB-H	13, 27, 46
Armed_Auto - DVB-H	43
Armed_Retrigger - DVB-H	43
Auto - DVB-H	43

B

B x T - DVB-H	40
Bandwith - DVB-H	16
Baseband Clipping - DVB-H	23
Baseband filter - DVB-H	21, 42
BxT - DVB-H	21

C

Cell Identification - DVB-H	17, 59
Cell Identification Pattern - DVB-H	59
Chip Clock Multiplier - DVB-H	37
Clipping - DVB-H	23
Clipping Level - DVB-H	24
Clipping Mode - DVB-H	24, 36
Clock Mode - DVB-H	32, 37
Clock Source - DVB-H	31, 38
Crest factor - Clipping - DVB-H	23, 36
Current Dynamic Range - DVB-H	31
Current Range Without Recalculation Maximum - DVB-H	48
Current Range Without Recalculation Minimum - DVB-H	49
Cut Off Frequency Factor - DVB-H	22
Cut Off Frequency Shift - DVB-H	21, 41

D

Data Rate - DVB-H	12, 38
Data Source - DVB-H	55
Deactivate DVB-H Standard	10
Default Settings - DVB-H	10, 42
Delay - Marker - DVB-H	31, 48
Delay - Trigger - DVB-H	28, 46
Divider - DVB-H	30
Duration - DVB-H	12, 38
DVB-H Standard	12

E

Execute Trigger - DVB-H	13, 27, 46
External Trigger Delay - DVB-H	28, 46
External Trigger Inhibit - DVB-H	29, 47

F

File Manger	11
Filter Parameter - DVB-H	21, 40
Filter Type - DVB-H	21, 42
Fix Marker Delay to Current Range - DVB-H	31
Fix marker to dynamic range - DVB-H	48
Frame Start Marker - DVB-H	29
Frequency - DVB-H	30

G

Generate Waveform File - DVB-H	12
Guard Interval - DVB-H	17

H

Hierarchy Mode - DVB-H	14
HP Source - DVB-H	15, 55

I

ID [4 hex] - DVB-H	17
Impulse Length - DVB-H	39
Impulse Length - Import	22
Impulse Length Auto State - DVB-H	40
Inner Bit Interleaver - DVB-H	15
Inner Coder - DVB-H	15, 56
Inner Interleaver Bit - DVB-H	56
Inner Interleaver Mode - DVB-H	16, 57
Inner Interleaver Tx Mode - DVB-H	16, 57
Inner Symbol Interleaver - DVB-H	16, 57

L

Load DVB-H Settings	11
---------------------------	----

M

Manual Trigger - DVB-H	27, 46
Marker - DVB-H	13
Marker Delay - DVB-H	31, 48
Marker Mode - DVB-H	29, 49
Measured External Clock - DVB-H	32
Modulation - DVB-H	16
MPE FEC - DVB-H	18, 59
Multiple Sample Clock Mode - DVB-H	32
Multiplier - DVB-H	32, 37
Multiprotocol Encapsulation Forward Error Correction - DVB-H	59

N

Number of Samples - DVB-H	12, 39
Number of Super Frames - DVB-H	12, 39
Nyquist filter - DVB-H	21, 42

O

OFDM/RF - DVB-H.....	58
OFDM/RF Alpha - DVB-H.....	57
OFDM/RF Guard Interval - DVB-H.....	58
OFDM/RF Modulation - DVB-H.....	58
ON/OFF Ratio Marker - DVB-H.....	30, 50
Open File Manager.....	11
Outer Coder - DVB-H.....	15, 56
Outer Interleaver - DVB-H.....	15, 56
Oversampling - DVB-H.....	40
Oversampling - Import.....	22
Oversampling Auto State - DVB-H.....	40

P

Pattern Marker - DVB-H.....	29
PN Scrambler - DVB-H.....	15, 56
Pulse Marker - DVB-H.....	29

R

Rate - DVB-H.....	15, 55
Recall Configuration - DVB-H.....	11
Recall DVB-H Settings.....	11
Restart Marker - DVB-H.....	29
Retrigger - DVB-H.....	43
Roll Off - DVB-H.....	21, 40
Running - Trigger - DVB-H.....	51
Running - Trigger - Trigger - DVB-H.....	27

S

Sample Clock Mode - DVB-H.....	32
Sample Clock Multiplier - DVB-H.....	32
Sample Rate - DVB-H.....	12, 39
Sample Rate Variation - DVB-H.....	22, 45
Save Configuration - DVB-H.....	11
Save DVB-H Settings.....	11
Set to Default - DVB-H.....	10, 42
Signal Duration - Trigger - DVB-H.....	27, 52
Signal Duration Unit - Trigger - DVB-H.....	26, 52
Standard - DVB-H.....	12, 45, 54
Standard Settings - DVB-H.....	10, 42
State - Clipping - DVB-H.....	23, 36
State - DVB-H.....	10, 45
Stop Signal Generation - DVB-H.....	13
Stopped - DVB-H.....	27
Super-Frame Start Marker - DVB-H.....	29

T

Time Slicing - DVB-H.....	18, 59
TPS Parameter Bits - DVB-H.....	18
TPS Table - DVB-H.....	18
Trigger - DVB-H.....	13
Trigger - Marker - DVB-H.....	13
Trigger Delay External - DVB-H.....	28, 46
Trigger Delay Other Baseband - DVB-H.....	28, 47
Trigger Inhibit External - DVB-H.....	29, 47
Trigger Inhibit Other Baseband - DVB-H.....	29, 47
Trigger Mode - DVB-H.....	26, 43
Trigger Mode Armed_Auto - DVB-H.....	26
Trigger Mode Armed_Retrigger - DVB-H.....	26
Trigger Mode Auto - DVB-H.....	26
Trigger Mode Retrigger - DVB-H.....	26
Trigger Mode Single - DVB-H.....	26
Trigger Source - DVB-H.....	28, 53

W

Waveform File - DVB-H.....	12
----------------------------	----